

## LineLazer™ III 3900/5900

**309413** Rev. B

*3300 psi (228 bar, 22.8 MPa) Maximum Working Pressure*

**LineLazer III 3900**  
**233688, 233689, 233664, 233694**

**LineLazer III 5900**  
**233690, 233691, 233627, 233695**

Patent Pending

All models not available in all countries.

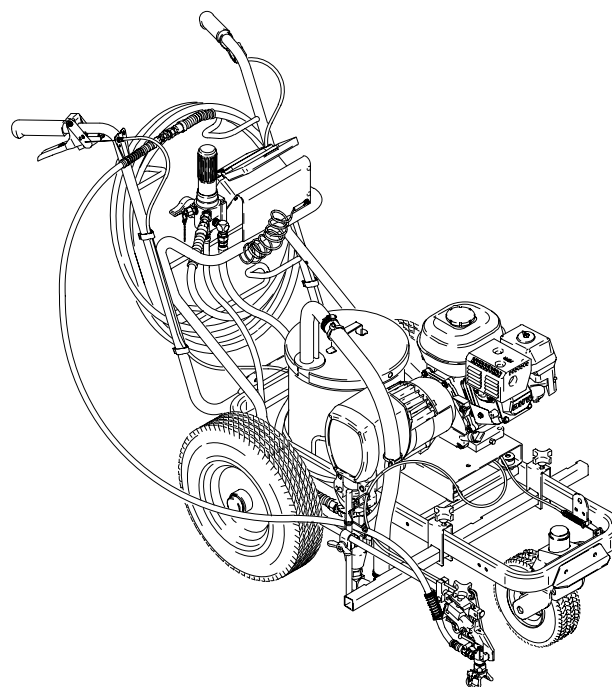

ti1935a

**233688**

• Controls .....	3
• Setup .....	5
• Startup .....	6
• Digital Tracking System™ (DTS) .....	12
• Cleanup .....	24
• Pressure Relief .....	24
• Error Codes .....	29

## ⚠ WARNING

**Fire and explosion hazard:** Solvent and paint fumes can ignite or explode.

**To help prevent a fire and explosion:**

- Use only in an extremely well ventilated area.
- Eliminate all ignition sources; such as pilot lights, cigarettes and plastic drop cloths (static arc hazard). Do not plug or unplug power cords or turn lights on or off in spray area.
- Ground Sprayer, object being sprayed, paint and solvent pails.
- Hold gun firmly to side of grounded pail when triggering into pail.
- Use only conductive airless paint hose.
- Do not use 1,1,1-trichloroethane, methylene chloride, other halogenated hydrocarbon solvents or fluids containing such solvents in pressurized aluminum equipment. Such use could result in a chemical reaction, with the possibility of explosion.
- Do not fill fuel tank while engine is running or hot.
- Do not flush with gasoline.

**Fluid injection and high pressure hazard:** High pressure spray or leaks can inject fluid into the body.

**To help prevent injection, always:**

- Engage trigger safety latch when not spraying.
- Keep clear of nozzle and leaks.
- Never spray without a tip guard.
- Do **PRESSURE RELIEF** if you stop spraying or begin servicing sprayer.
- Do not use components rated less than sprayer *Maximum Working Pressure*.
- Never allow children to use this unit.

If high pressure fluid pierces your skin, the injury might look like "just a cut". But it is a serious wound! Get immediate medical attention.

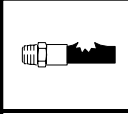

## ⚠ ADVERTÊNCIA

**Perigo de incêndio e explosão:** os solventes e os vapores da pintura poderão explodir ou incendiar.

**Para ajudar a evitar incêndio e explosão:**

- Utilize unicamente em áreas extremamente bem ventiladas.
- Elimine todas as fontes de ignição, tais como luzes piloto, cigarros e arcos de estática resultantes dos plásticos de proteção. Não ligue nem desligue os cabos de alimentação ou as luzes numa área de pulverização.
- Ponha em contato com a terra o pulverizador, o objeto a ser pulverizado, e os baldes de tinta e de solventes.
- Segure a pistola firmemente de encontro ao lado do balde em contato com a terra, quando estiver descarregando para dentro do mesmo.
- Utilize somente tubos flexíveis condutores para pintura a alta pressão.
- Não utilize 1,1,1-tricloroetano, cloreto de metileno, outros solventes de hidrocarbonetos halogenados ou líquidos contendo tais solventes em equipamento de alumínio pressurizado. Tal utilização poderá resultar numa reação química, com possibilidade de explosão.
- Nunca abasteça o depósito de combustível com o motor em funcionamento ou quente.
- Não faça a descarga com gasolina.

**Perigo de injeção de líquidos à alta pressão:** a pulverização ou vazamentos à alta pressão podem injetar líquido no corpo.

**Para ajudar a evitar injeção de líquido, faça sempre o seguinte:**

- Engate o trinco de segurança do gatilho quando não estiver pulverizando.
- Mantenha-se afastado dos bocais e locais onde há vazamentos.
- Nunca pulverize sem que haja uma proteção na extremidade.
- **ALIVIE A PRESSÃO** quando parar de pulverizar e antes de iniciar a manutenção do pulverizador.
- Não utilize componentes com uma classificação inferior à do pulverizador *Pressão Máxima de Trabalho*.
- Nunca permita que crianças utilizem esta unidade.

Se o líquido a alta pressão penetrar na sua pele, o ferimento poderá parecer "simplesmente um corte". Mas é um ferimento grave! Procure o médico imediatamente.

## ⚠ MISE EN GARDE

**Danger d'incendie et d'explosion :** les gaz de solvant et de peinture peuvent s'enflammer ou exploser.

**Pour éviter les risques d'incendie et d'explosion :**

- N'utiliser l'appareil que dans une zone extrêmement bien aérée.
- Éliminer toute source d'inflammation ; telle que veilleuses, cigarettes et arcs d'électricité statique créés par les toiles de peintre en plastique. Ne pas brancher et débrancher de cordons électriques, ou allumer et éteindre des lumières dans la zone de pulvérisation.
- Mettre à la terre le pulvérisateur, l'objet à pulvériser ainsi que les seaux de peinture et de solvants.
- Tenir le pistolet fermement contre la paroi d'un seau mis à la terre lorsqu'on pulvérise dans le seau.
- N'utiliser qu'un flexible pour peinture pulvérisée sans air.
- Ne jamais utiliser de trichloroéthane 1,1,1, de chlorure de méthylène, d'autres solvants à base d'hydrocarbures halogénés, ni de produits contenant de tels solvants dans un équipement sous pression en aluminium. Cela pourrait provoquer une réaction chimique avec risque d'explosion.
- Ne jamais remplir le réservoir d'essence lorsque le moteur est chaud ou en marche.
- Ne pas rincer avec de l'essence.

**Danger d'injection de fluide et haute pression :** la pulvérisation sous haute pression ou les fuites peuvent injecter des fluides dans le corps.

**Pour éviter les risques d'injection, toujours :**

- Bloquer le loquet de sécurité de la gâchette à la fin de la pulvérisation.
- Se tenir loin de la buse et des fuites.
- Ne jamais pulvériser sans anti-gouttes.
- **DÉCHARGER LA PRESSÃO** à la fin de la pulvérisation ou avant de réparer le pulvérisateur.
- Ne pas utiliser de composants dont la pression nominale est inférieure à la *pression maximale de service du système*.
- Ne jamais permettre aux enfants d'utiliser cet appareil.

Si un fluide haute pression perce la peau, la blessure peut paraître une "simple coupure" Mais il s'agit bien d'une lésion grave! Consulter immédiatement un médecin.

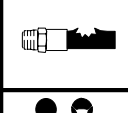

## ⚠ ADVERTENCIA

**Perigo de incendio o explosión:** Los gases de los disolventes y de la pintura pueden inflamarse o provocar una explosión.

**Para prevenir incendios y explosiones:**

- Use únicamente en un área muy bien ventilada.
- Suprima todas las fuentes de ignición; como luces piloto, cigarrillos y arcos estáticos de carpetas plásticas para protección contra pintura. No enchufe ni desenchufe cables de alimentación ni apague ni encienda las luces en un área de pulverización.
- Ponga a tierra el pulverizador, el objeto que recibe el chorro pulverizado, las cubetas de pintura y disolvente.
- Sostenga firmemente la pistola a un lado de la cubeta puesta a tierra cuando dispere dentro de ella.
- Use solamente mangueras para pintura conductora sin aire.
- No utilice nunca tricloroetano-1,1,1, cloruro de metileno ni otros disolventes a base de hidrocarburos halógenos o fluidos que contengan dichos disolventes en un equipo a presión de aluminio. El uso de estas sustancias puede provocar una intensa reacción química, con riesgos de explosión.
- Nunca llene el estanque de combustible mientras el motor esté en marcha o caliente.
- No lave con gasolina.

**Perigo de inyección de fluido y alta presión:** por la pulverización o las filtraciones a alta presión se pueden inyectar fluidos en el organismo.

**Para prevenir la inyección en la piel, siempre:**

- Enganche el seguro del gatillo cuando no use el pulverizador.
- No se acerque a la boquilla ni a las filtraciones.
- Nunca aplique fluido pulverizado sin un guardaboquilla.
- Realice el **ALIVIO DE PRESIÓN** si deja de pulverizar fluido o repara el pulverizador.
- No use componentes de capacidad nominal inferior a la *presión máxima de operación del pulverizador*.
- No permita que niños usen esta unidad.

Si fluido de alta presión le penetra la piel, la lesión podría parecer "sólo un corte". ¡Es una lesión seria! Consulte de inmediato al médico.

# CONTROLS / CONTROLES / COMMANDES / CONTROLES

On/Off Switch / Interruptor de ligar e desligar / Interrupteur marche/arrêt / Interruptor de encendido/apagado

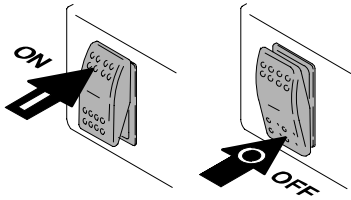

On/Off Switch / Interruptor de ligar e desligar / Interrupteur marche/arrêt / Interruptor de encendido/apagado



Pressure Control / Controle da pressão / Système de contrôle de la pression / Dispositivo de control de la presión

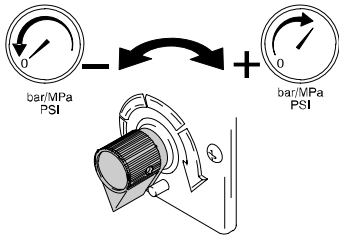

Drain Valve / Válvula de drenagem / Vidange / Válvula de vaciado

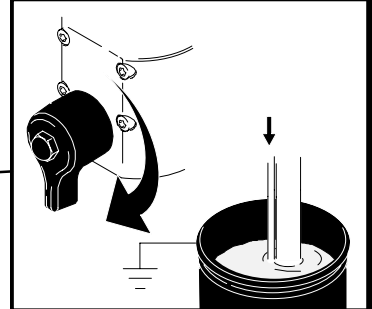
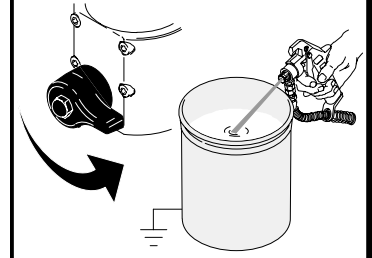

Turning / Volta / Virage / Viraje

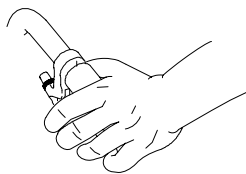

Spray / Pulverização / Pulvérisation / Pulverización

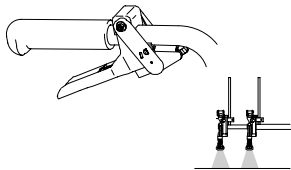

Display / affichage / visualización / indicador

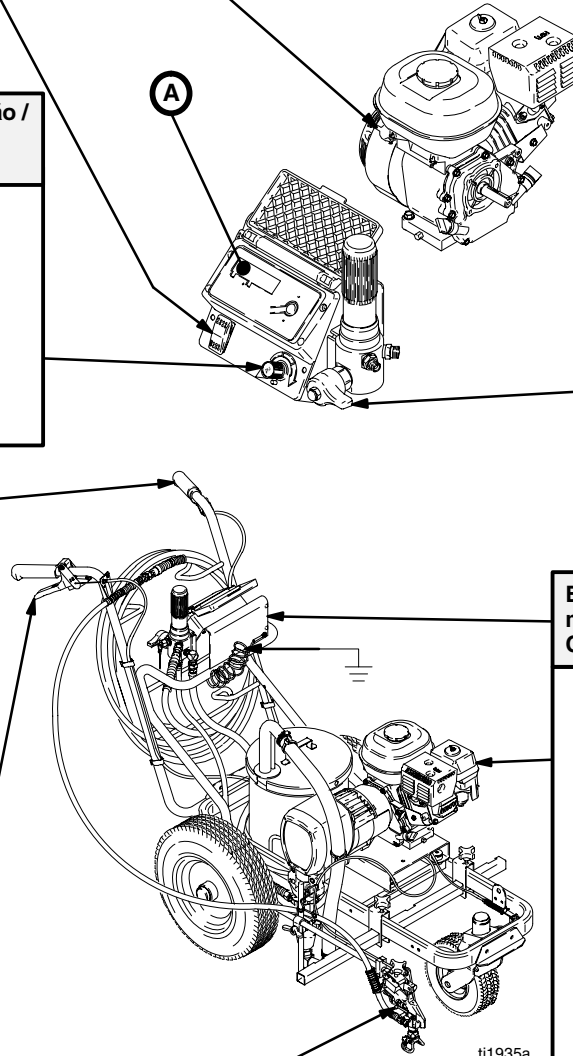

Engine Controls / Controles do motor / Commandes de moteur / Controles del motor

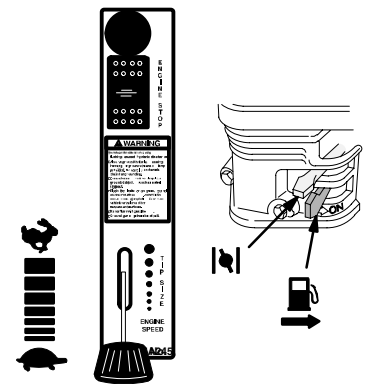

Trigger Lock / Fecho do gatilho / Loquet de sécurité / Seguro del gatillo

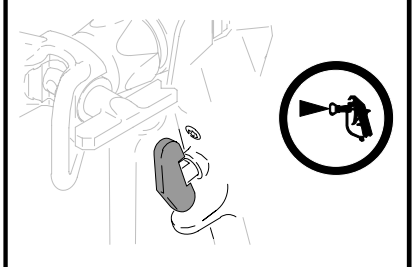

# Pressure Relief



## Pressure Relief

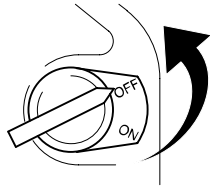
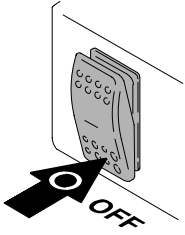

1. Set pump switch OFF.  
Turn engine **OFF**.



## Pressure Relief

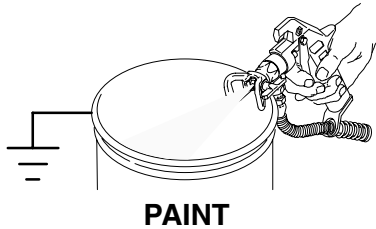
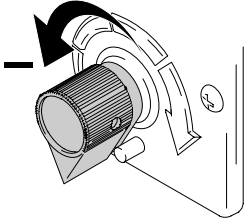

2. Turn pressure to lowest setting.  
Trigger gun to relieve pressure.



## Pressure Relief

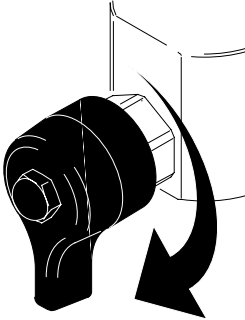

3. Turn prime valve down.

# Setup

1. Ground sprayer with grounding clamp.

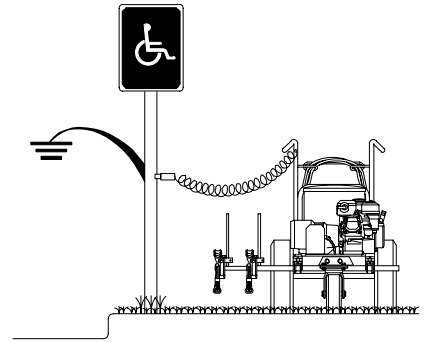

2. Fill throat packing nut with TSL to prevent premature packing wear.  
Do this each time you spray and store.

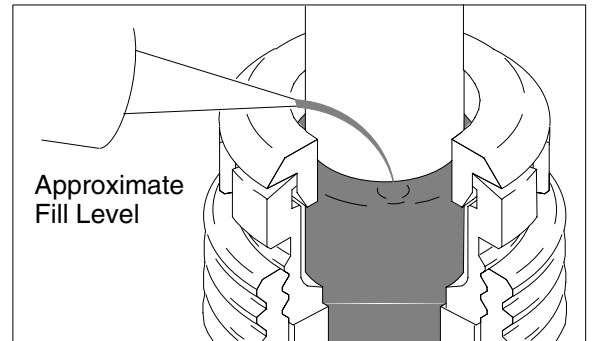

3. Check engine oil level. Add SAE 10W-30 (summer) or 5W-20 (winter), if necessary.

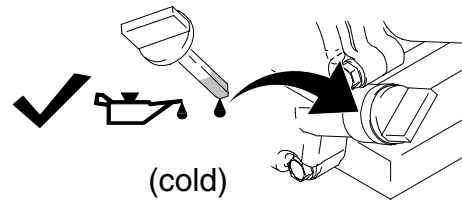

4. Fill fuel tank.

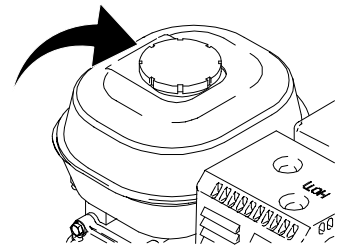

# Startup

---

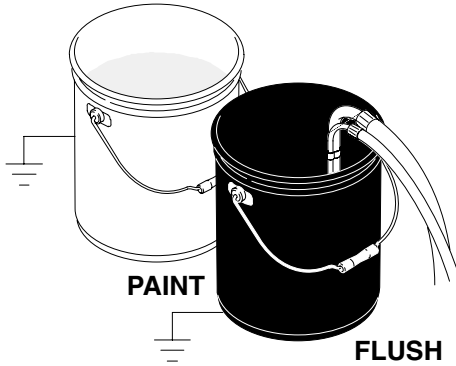

1. Place suction tube and drain tube in grounded metal pail partially filled with flushing fluid. Attach ground wire to pail and to true earth ground.
- 

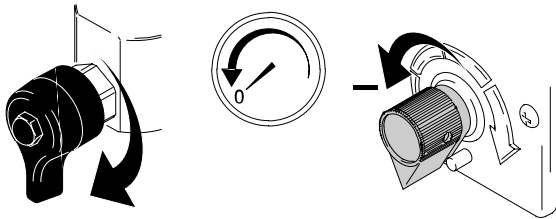

2. Turn prime valve down.  
Turn pressure control to lowest pressure.
- 

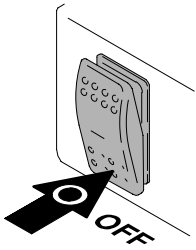

3. Set pump switch OFF.
-

# Startup

---

## 4. Start engine

a. Move fuel valve to open



b. Move choke to closed

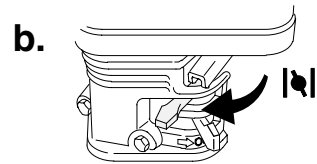

c. Set throttle to fast

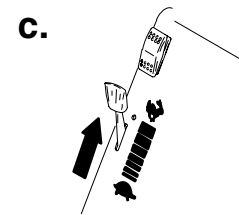

d. Set engine switch ON

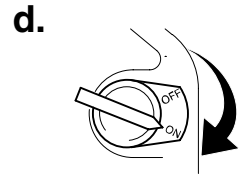

e. Pull starter cord

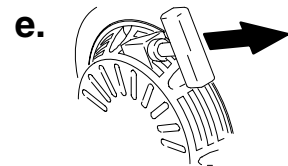

f. After engine starts, move choke to open

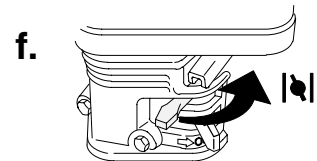

g. Set throttle to desired setting

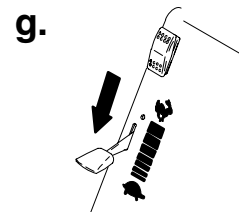

– Digital display is functional after engine starts –

# Startup

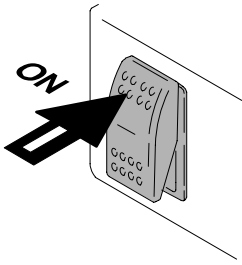

5. Set pump switch ON.  
– Pump/clutch is now active –

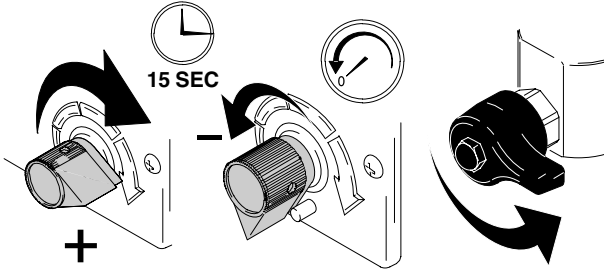

6. Increase pressure enough to start pump stroking and allow fluid to circulate for 15 seconds; turn pressure down, turn prime valve horizontal.

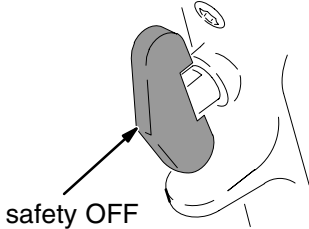

7. Take spray gun trigger safety OFF.

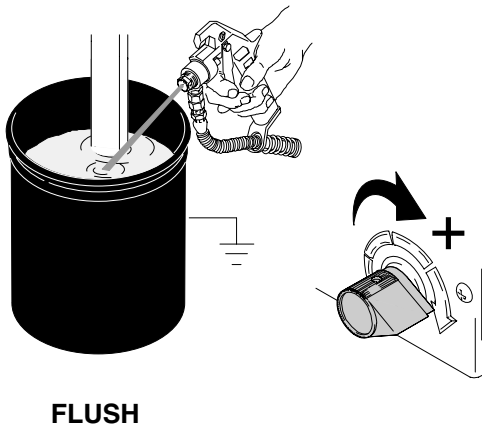

8. Hold gun against grounded metal flushing pail. Trigger gun and increase fluid pressure slowly until pump runs smoothly.



# Startup

9. Place siphon tube in paint pail.

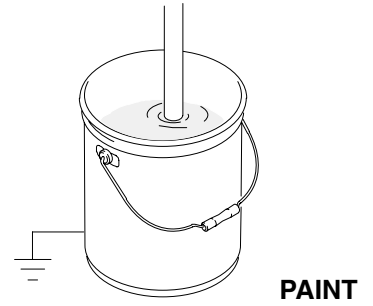

10. Trigger gun again into flushing fluid pail until paint appears. Assemble tip and guard, page 9.

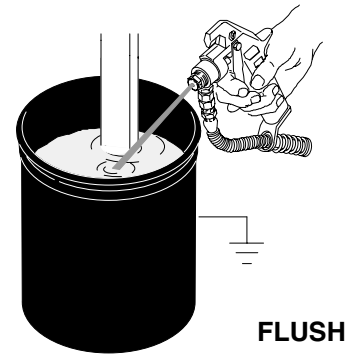

## SwitchTip and Guard Assembly

1. Engage trigger safety.



2. Insert SwitchTip™.  
Insert seat and OneSeal™.

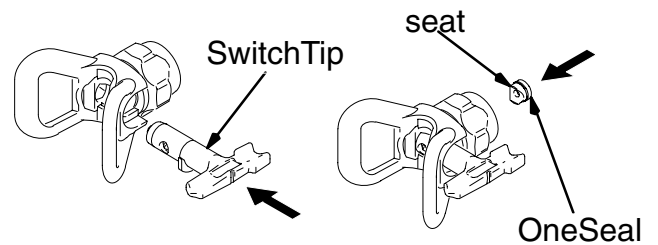

3. Screw assembly onto gun. Hand tighten.

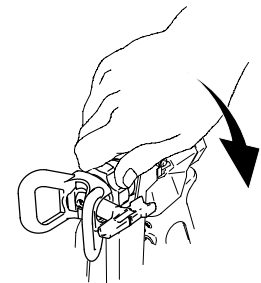

# Gun Placement

---

## Install Gun

---

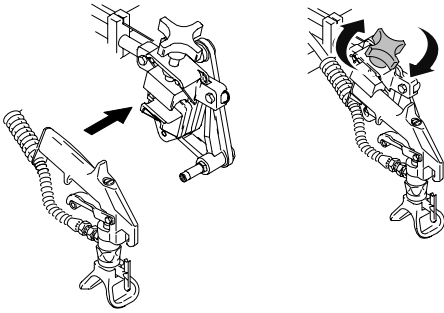

1. Insert gun into gun holder.  
Tighten clamp.

---

## Position Gun

---

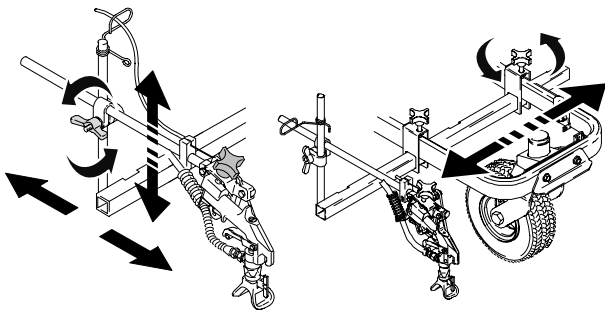

2. Position gun up/down, forward/reverse,  
left/right

---

## Select Gun

---

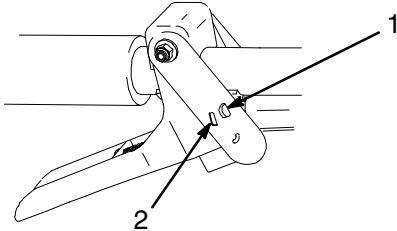

3. Connect gun cables to left or right gun  
selector plates.

- a. **One gun:** Disconnect one gun selector  
plate from trigger.
- b. **Both guns simultaneously:** Adjust both  
gun selector plates to same position.
- c. **Solid-skip and skip-solid:** Adjust solid-line gun  
to position 1 and skip-line gun to position 2

# Trigger Sensor Adjustment

---

Adjust screw in handle \_\_\_\_\_  
to synchronize spray icon  with fluid spray.

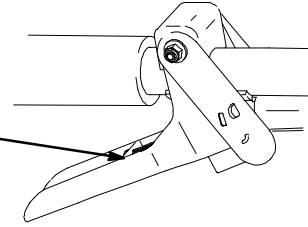

---

## Clearing Tip Clogs

---

1. Release trigger, put trigger safety ON. Rotate SwitchTip. Take trigger safety OFF and trigger gun to clear the clog.

 Never point gun towards your hand or into a rag!

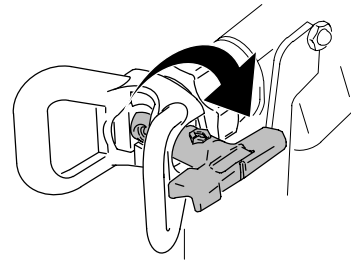

2. Put trigger safety ON, return SwitchTip to original position, take trigger safety OFF and continue spraying.

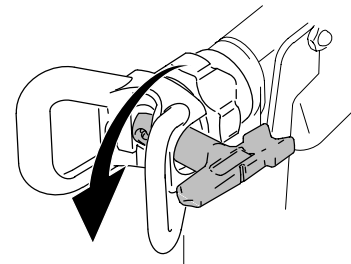

---

## Digital Tracking System™ (DTS)

---

### Operation



Short press moves to next display.  
Long press changes units or resets data.

---

### Main Menu

---



or



#### 1. Start engine, page 7.

Sprayer Model momentarily displays,  
e. g., L5900 = LineLazer 5900

Pressure display appears. Dashes appear when pressure is  
less than 200 psi (14 bar, 1.4 MPa).

2. Short press DTS button to move to Speed (miles per hour or kilometers per hour).

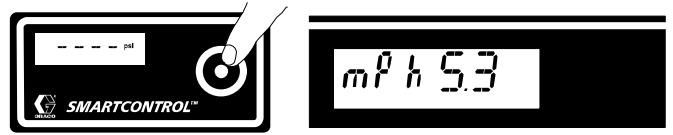

3. Short press DTS button to move to rolling average Film Build (mils or microns).

**Note:** Displays the average film build over the last 20 ft (6 m) sprayed. The proper line width must be selected, step 7.

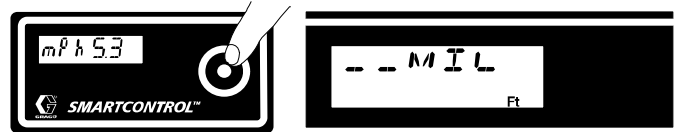

4. Short press DTS button to move to Job Distance (ft or m).

**Note:** Displays the linear line length applied since the last reset. See Reset screen, step 9.



5. Short press DTS button to move to Job Material Counter.

**Note:** Displays material sprayed (gallons or liters x 10) since the last reset.

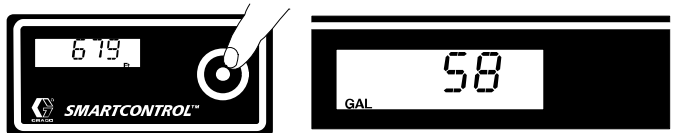

---

## DTS

---

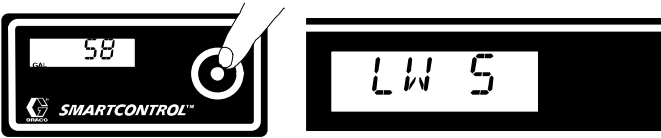

6. Short press DTS button to move to Line Width (LW) Selector.

**Note:** Displays the line width used to calculate film build (in. or cm).



7. Press and hold DTS button to change LW. LW changes from 2 – 12 in. (5 – 30 cm). Release DTS button when desired LW appears.

**Note:** If your distance reading is feet, LW is inches. If your distance reading is meters, LW is centimeters.



8. Short press DTS button to move to Job Film Build.

**Note:** Displays the average film build (mils or microns) since the last reset.

---

9. Short press DTS button to move to job  
RESET display

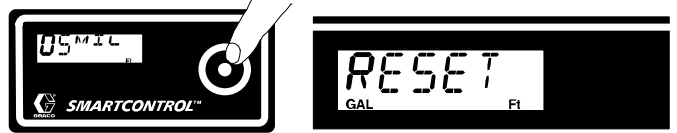

- 
10. Press and hold DTS button to reset job  
distance, job material and job film build  
values to zero,

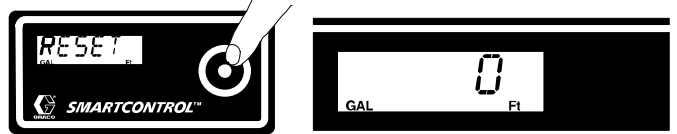

**OR**

- short press DTS button to return to  
Pressure display.



---

## DTS Secondary Menu

---

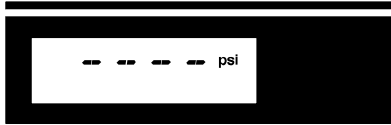

or



1. Start engine, page 7.  
Pressure display appears.

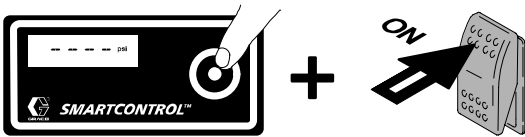

2. Simultaneously press DTS button and set pump on/off switch on.



Measure Mode display appears



3. To use Measure Mode, press and hold DTS button until distance display appears.



To skip Measure Mode, short press DTS button, step 4.

- a. Short press DTS again to start measuring.  
ON appears on left side of display.

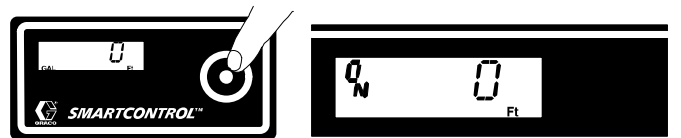

- b. Short press DTS again to stop measuring.

**Note:** Repeated short presses of DTS alternately turn Measure mode on and off.



- c. Press and hold DTS button to reset to zero.



- d. Set pump ON/OFF switch OFF to exit Measure mode.

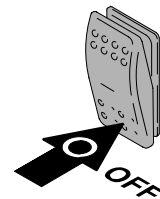

---

## DTS Secondary Menu

---

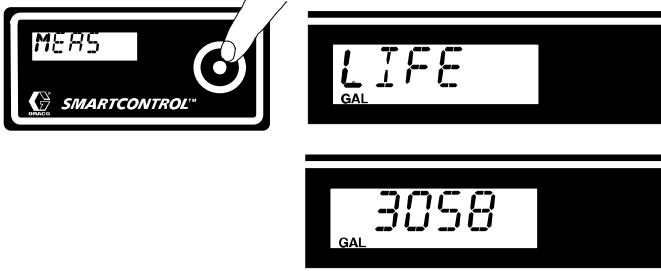

4. Short press DTS button to move from MEAS display to LIFE material counter display.

LIFE appears momentarily, then life time gallons (liters x 10) sprayed above 1000 psi (70 bar, 0,7 MPa).

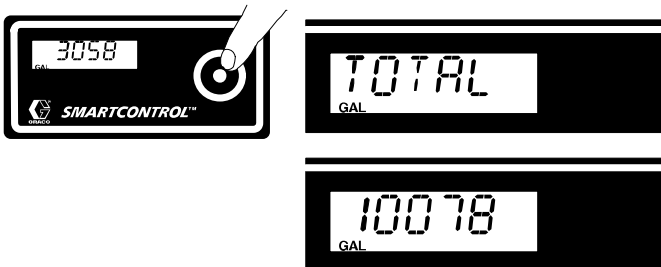

5. Short press DTS button to move to Total Material Counter. TOTAL appears momentarily, then total gallons (liters x 10) pumped at all pressures.

6. Short press DTS button to move to SPRAY (distance). MILES or KILOMETERS scrolls across display, then total length of lines applied.

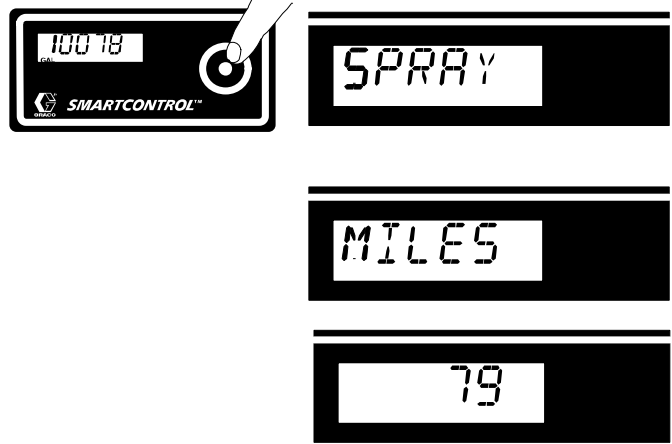

7. Short press DTS button to move to TOTAL (distance). MILES or KILOMETERS scrolls across display, then total distance traveled, with or without spraying.

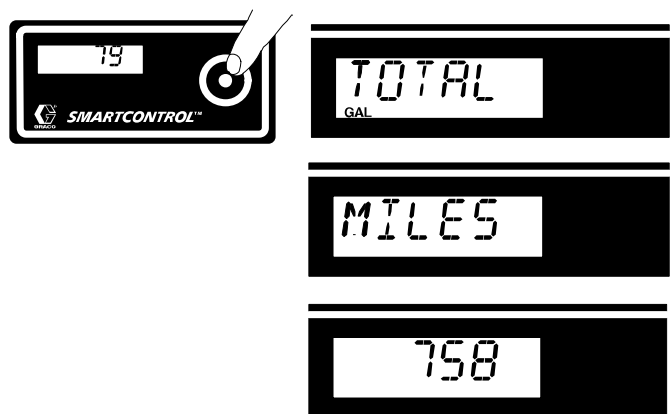

---

## DTS Secondary Menu

---



8. Short press DTS button to move to Engine Hour display. LIFE and the clock symbol will appear, then the lifetime engine run hours.



9. Short press DTS button to move to live Engine RPM display.



10. Press DTS button to move to stored error code. Press and hold DTS button to clear error code to E=00. See Manual 309414.
-

11. Short press to move to distance calibration display.

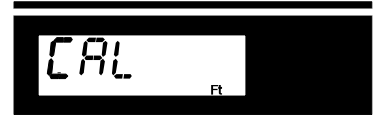

12. Go to next step to calibrate distance meter.

OR

Short press to move back to step 2., MEAS display.



13. To calibrate distance meter, accurately measure out 25 ft or 10 m and move machine to start point. While CAL is showing, press and hold (8 seconds) DTS button until 25 ft or 10 m flashes.



---

## DTS Secondary Menu

---

Roll 25 ft or 10 m

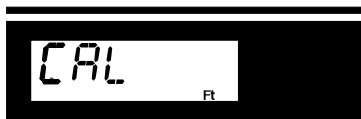
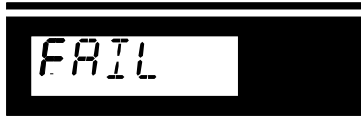

14. Move LineLazer exactly 25 ft or 10 m. Do not back up. Press DTS button. DONE displays if calibration was successful or FAIL if not successful. Press DTS again to return to CAL screen.

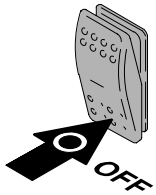

15. Turn pump switch OFF at any time to exit **Secondary Menu** and return to pressure display.

---

## DTS Change Display Units:

---

### Pressure:

Press and hold (8 seconds) DTS button to change pressure units (psi, bar, MPa), to desired units.

Short press to move to **Volume** display.



### Volume:

Press and hold (8 seconds) DTS button to change volume units (GAL, LITER10).

Short press to move to **Distance** display.



### Distance:

Press and hold (8 seconds) DTS button to change distance units (ft or m)

Short press to move to **Pressure** display.



**Note:** This also changes film build (mils or microns) and speed (mph or kph)

# Cleanup

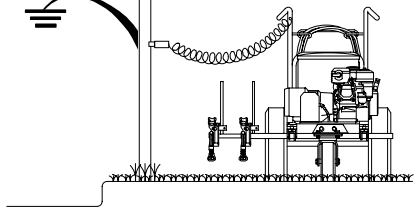

1. Ground sprayer with grounding clamp.



**Pressure Relief**

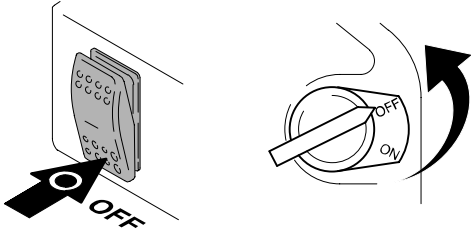

2. Set pump switch OFF.  
Turn engine **OFF**.



**Pressure Relief**

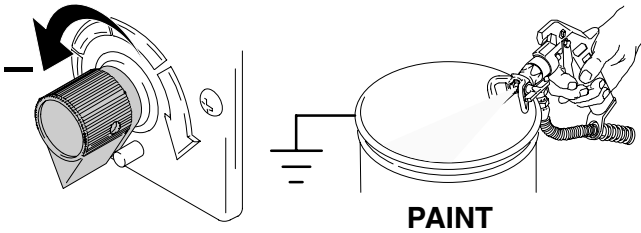

3. Turn pressure to lowest setting.  
Trigger gun to relieve pressure



**Pressure Relief**

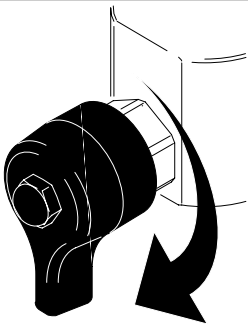

4. Turn prime valve down.



# Cleanup

---

5. Remove guard and SwitchTip.

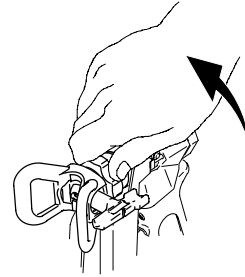

6. Unscrew bowl, remove filter. Assemble without filter. Clean filter.

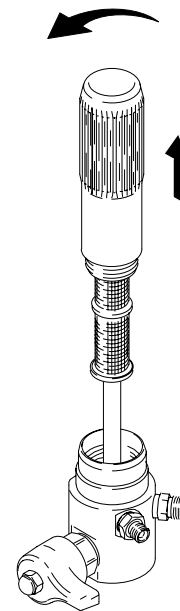

7. Clean filter, guard and SwitchTip in flushing fluid.

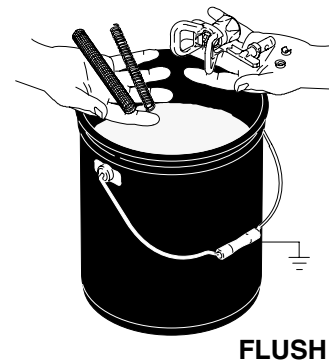

# Cleanup

---

8. Remove siphon tube set from paint and place in flushing fluid. Use water for water base paint and mineral spirits for oil base paint.

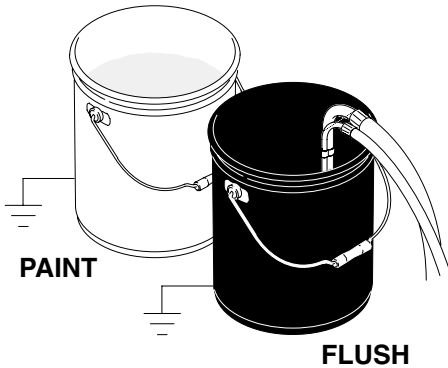

9. Turn engine **ON** and start engine. Set pump switch **ON**.

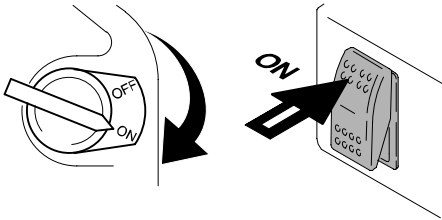

10. Turn prime valve horizontal.

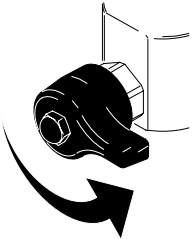

11. Hold gun against paint pail. Take trigger safety **OFF**. Trigger gun until flushing fluid appears. Turn pressure control up until motor begins to drive pump.

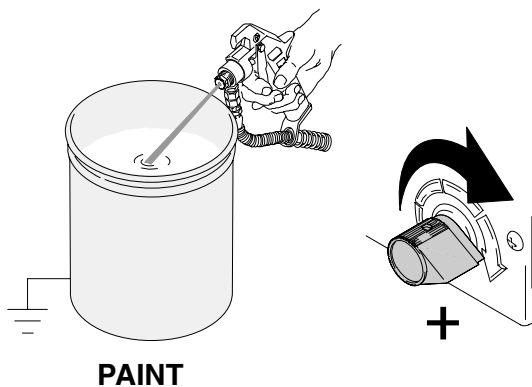

# Cleanup

---

12. Move gun to flushing pail, hold gun against pail, trigger gun to thoroughly flush system.

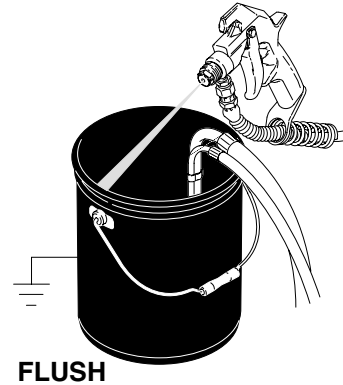

13. Trigger gun and turn prime valve down. Release gun trigger. Allow flushing fluid to circulate for approximately 20 seconds to clean drain tube.

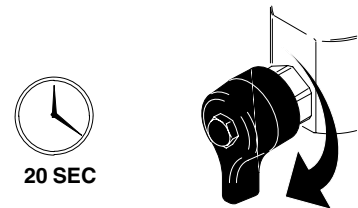

14. Raise siphon tube above flushing fluid and run sprayer for 15 to 30 seconds to drain fluid. Turn pump switch OFF. Turn engine **OFF**.

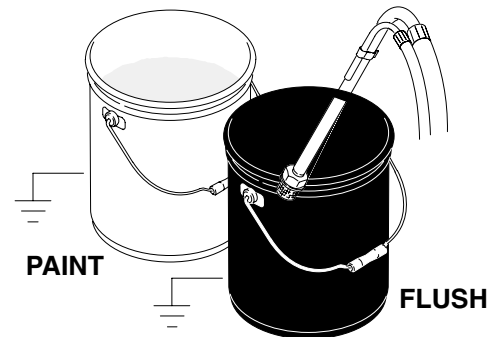

**Caution:** If flushing with water, do not leave water in sprayer. Flush again with mineral spirits, oil or Pump Armor and leave this protective coating in the sprayer to help prevent freezing or corrosion and increase sprayer life.

---

# Cleanup

---

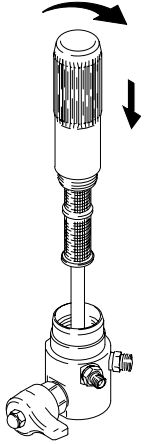

15. Make sure plastic center tube is tightened securely. Install filter bowl and filter. Hand tighten filter bowl. Hand tighten gun handle.

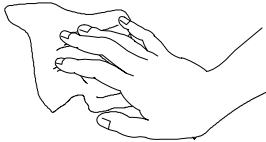

16. Wipe sprayer, hose and gun with a rag soaked in water or mineral spirits.



17. Clean tip, guard and gasket with a soft bristle brush to prevent part failure due to dried materials. Assemble parts and attach loosely onto gun.

# DTS Error Codes

---

E:02

E:03

E:06

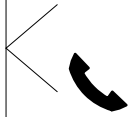
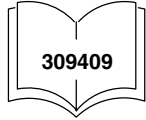

Service

Reference Repair Manual 309411 or call your distributor for service

# Graco Warranty

Graco warrants all equipment listed in this manual which is manufactured by Graco and bearing its name to be free from defects in material and workmanship on the date of sale to the original purchaser for use. With the exception of any special extended or limited warranty published by Graco, Graco will, for a period of twelve months from the date of sale, repair or replace any part of the equipment determined by Graco to be defective. This warranty applies only when the equipment is installed, operated and maintained in accordance with Graco's written recommendations.

This warranty does not cover, and Graco shall not be liable for general wear and tear, or any malfunction, damage or wear caused by faulty installation, misapplication, abrasion, corrosion, inadequate or improper maintenance, negligence, accident, tampering, or substitution of non-Graco component parts. Nor shall Graco be liable for malfunction, damage or wear caused by the incompatibility of Graco equipment with structures, accessories, equipment or materials not supplied by Graco, or the improper design, manufacture, installation, operation or maintenance of structures, accessories, equipment or materials not supplied by Graco.

This warranty is conditioned upon the prepaid return of the equipment claimed to be defective to an authorized Graco distributor for verification of the claimed defect. If the claimed defect is verified, Graco will repair or replace free of charge any defective parts. The equipment will be returned to the original purchaser transportation prepaid. If inspection of the equipment does not disclose any defect in material or workmanship, repairs will be made at a reasonable charge, which charges may include the costs of parts, labor, and transportation.

Graco's sole obligation and buyer's sole remedy for any breach of warranty shall be as set forth above. The buyer agrees that no other remedy (including, but not limited to, incidental or consequential damages for lost profits, lost sales, injury to person or property, or any other incidental or consequential loss) shall be available. Any action for breach of warranty must be brought within two (2) years of the date of sale.

**GRACO MAKES NO WARRANTY, AND DISCLAIMS ALL IMPLIED WARRANTIES OF MERCHANTABILITY AND FITNESS FOR A PARTICULAR PURPOSE IN CONNECTION WITH ACCESSORIES, EQUIPMENT, MATERIALS OR COMPONENTS SOLD BUT NOT MANUFACTURED BY GRACO.** These items sold, but not manufactured by Graco (such as electric motors, gas engines, switches, hose, etc.), are subject to the warranty, if any, of their manufacturer. Graco will provide purchaser with reasonable assistance in making any claim for breach of these warranties.

In no event will Graco be liable for indirect, incidental, special or consequential damages resulting from Graco supplying equipment hereunder, or the furnishing, performance, or use of any products or other goods sold hereto, whether due to a breach of contract, breach of warranty, the negligence of Graco, or otherwise.

## **FOR GRACO CANADA CUSTOMERS**

The parties acknowledge that they have required that the present document, as well as all documents, notices and legal proceedings entered into, given or instituted pursuant hereto or relating directly or indirectly hereto, be drawn up in English. Les parties reconnaissent avoir convenu que la rédaction du présente document sera en Anglais, ainsi que tous documents, avis et procédures judiciaires exécutés, donnés ou intentés à la suite de ou en rapport, directement ou indirectement, avec les procédures concernées.

## **ADDITIONAL WARRANTY COVERAGE**

Graco does provide extended warranty and wear warranty for products described in the "Graco Contractor Equipment Warranty Program".

# Graco Phone Number

**TO PLACE AN ORDER,** contact your Graco distributor, or call this number to identify the distributor closest to you:  
**1-800-690-2894 Toll Free.**

*All written and visual data contained in this document reflects the latest product information available at the time of publication.  
Graco reserves the right to make changes at any time without notice.*

**Sales Offices:** Minneapolis  
**International Offices:** Belgium, Korea, Hong Kong, Japan

**GRACO INC. P.O. BOX 1441 MINNEAPOLIS, MN 55440-1441**

**<http://www.graco.com>**

PRINTED IN U.S.A. 309413 2/2002, Revised 5/2004