

Instruction Manual

Battery Charger

309502 rev.F

Part No. 117427, Single Bay Charger, Series B, North America (N.A.)

Part No. 120110, Single Bay Charger, Series B, Australia

Part No. 117429, Four Bay Charger, Series B, N.A.

Part No. 120107, Four Bay Charger, Series B, Australia



Important Safety Instructions

Read all warnings and instructions in this manual.
Save these instructions.

CAUTION

The Graco Matrix Battery Charger must only be used with the Matrix Fluid Management System. The Graco warranty is void if the battery charger or batteries are used with a non-Graco product.



**Part No. 117429, N.A.
(120107, Australia)
Four Bay Charger**



PROVEN QUALITY. LEADING TECHNOLOGY.

Contents

Manual Conventions	2	Diagnostics	5
Warnings	3	Parts	6
Installation	4	Technical Data	7
Descriptions	4	Dimensions	8
Wall Mounting	4	Graco Standard Warranty	10
Charging Batteries	4	Graco Phone Numbers	10
Recharging “In-Use” Batteries	4		
Recharging a “Dead” Battery	4		

Manual Conventions

Warning

 WARNING

WARNING indicates a potentially hazardous situation which, if not avoided, could result in death or serious injury.

Caution





CAUTION
CAUTION indicates a potentially hazardous situation which, if not avoided, may result in property damage or destruction of equipment.

Note

 A note indicates additional helpful information.

Warnings

The following warnings include general safety information for this equipment and its application. More specific warnings are included in the text where appropriate.

 WARNING	
	<p>FIRE AND EXPLOSION HAZARD</p> <p>When flammable fluids are present in the work area, such as gasoline and windshield wiper fluid, be aware that flammable fumes can ignite or explode. To help prevent fire and explosion:</p> <ul style="list-style-type: none"> • Use equipment only in well ventilated area. • Eliminate all ignition sources, such as cigarettes and portable electric lamps. • Keep work area free of debris, including rags and spilled or open containers of solvent and gasoline. • Do not plug or unplug power cords or turn lights on or off when flammable fumes are present. • Ground equipment. • Use only grounded hoses. • If there is static sparking or you feel a shock, stop operation immediately. Do not use equipment until you identify and correct the problem.
	<p>BATTERY SAFETY</p> <p>The battery may leak, explode, cause burns, or cause an explosion if mishandled:</p> <ul style="list-style-type: none"> • You must use the battery type specified for use with the equipment. • Sparking can occur when changing batteries. Only replace the battery in a non-hazardous location, away from flammable fluids or fumes. • Handle and dispose of battery properly - do not short circuit, charge, force over discharge, disassemble, crush, penetrate, incinerate, or heat the battery to a temperature exceeding 185° F (85° C).
	<p>EQUIPMENT MISUSE HAZARD</p> <p>Misuse can cause death or serious injury.</p> <ul style="list-style-type: none"> • Do not exceed the maximum working pressure or temperature rating of the lowest rated system component. See Technical Data in all equipment manuals. • Use fluids and solvents that are compatible with equipment wetted parts. See Technical Data in all equipment manuals. Read fluid and solvent manufacturer's warnings. • Check equipment daily. Repair or replace worn or damaged parts immediately. • Do not alter or modify equipment. • Use equipment only for its intended purpose. Call your Graco distributor for information. • Route hoses and cables away from traffic areas, sharp edges, moving parts, and hot surfaces. • Do not use hoses to pull equipment. • For professional use only. • Comply with all applicable safety regulations.
	<p>ELECTRIC SHOCK HAZARD</p> <p>Improper grounding, setup, or usage of the system can cause electric shock.</p> <ul style="list-style-type: none"> • Turn off and disconnect power cord before servicing equipment. • Use only grounded electrical outlets. • Use only 3-wire extension cords. • Ensure ground prongs are intact on sprayer and extension cords.

Installation

Descriptions

- **Part No. 117427 N.A., 120110 Australia** - is free standing and can be placed on most horizontal flat surfaces or wall mounted.

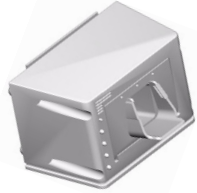

- **Part No. 117429 N.A. 120107 Australia** - is designed to be wall mounted, but it can also be free standing and placed on most horizontal flat surfaces. This model is expandable to a five or six bay charger by ordering extender(s), part no. 117435. **Part No. 117435 - is an extender for a four bay Battery Charger 117429 ONLY.** Adding one or a maximum of two extenders can expand Part No. 117429 from a four bay charger into a five or six bay unit. See Battery Charger Extender Instruction Manual (309499).



Wall Mounting

The chargers can be wall mounted using wall anchors (not supplied). See **Dimensions**, page 8.

Charging Batteries

WARNING



Batteries may leak, explode, cause burns or cause an explosion if mishandled. Read **BATTERY SAFETY**, page 3.

Recharging “In-Use” Batteries

1. Insert discharged batteries into the charger adapter cups. Each of the four indicator lights flash. The yellow “Charge” indicator light stays on to indicate the batteries are charging.
2. The charger eventually enters a balancing mode where the yellow “Charge” light changes from solid on to flashing. This generally occurs in about two hours when recharging a completely discharged battery.
3. The green “Ready” light comes on when recharging is complete indicating a fully charged battery.
4. Batteries can be removed for use or they can remain in the charger, which automatically switches to the maintenance mode. The maintenance mode keeps the batteries at full charge without damaging the battery or charger.



The charger indicator lights will signal the condition of the battery. See **Diagnostics** on page 5 for a description of the lights.



Batteries can be left on the charger indefinitely without damage to the battery.

Recharging a “Dead” Battery

A completely discharged battery has no voltage across the contacts and acts like an open circuit preventing the charger from operating. If you insert the battery into the adapter cup and NO lights appear, the battery might be completely “dead” but still rechargeable.

1. Insert the battery into the charger.
2. Press and hold the black “Start” button for 5 seconds until the green “Ready” light comes on and the yellow “Charge” light begins to flash. This is a trickle charge (24 hours).

WARNING



To reduce the risk of electric shock, only use Graco batteries with the Graco charger. Do not insert a foreign object into the adapter cup.

Diagnostics

Appearance	Description
No lights	Check the battery charger fuse.
	Verify that the battery and charger contacts are clean and in good shape.
	Attempt the Recharging a “Dead” Battery on page 4. If after 4 - 5 attempts this process does not work, the battery is spent and cannot be recharged. Remove the battery and dispose of it properly.
Green “Ready” light blinks	Charger ready to accept battery for charging.
Yellow “Charge” light blinking	Normal charging process (balancing mode).
Yellow “Charge” light stays on	Normal charge mode.
Yellow “Charge” light blinks with green “Ready” light on	Normal “Trickle Charge” mode (24 hour charge).
Green “Ready” stays on	Indicates a full charge. Use the battery or leave it in the charger. The automatic “Maintenance Mode” holds the batteries at full charge.
Orange “Temp” light comes on	No action required. Indicates that the charger has automatically shut down because of battery temperature. When battery cools, normal charging resumes.
Orange “Temp” light flashing	No action required. Charger has entered a reduced charge mode.
Red “Defective” light stays on	Press “Start” button to attempt to revive battery using the 24 hour “Trickle Charge” process. If “Defective” light stays on properly dispose of faulty battery.
Significantly reduced battery life between charges	Battery may be developing a memory effect. Pressing the “Start” button starts a trickle charge process which might improve battery life.
Yellow “Charge” and orange “Temp” lights fast flash	Defective wall outlet. Consult an electrician.

Parts

**Part No. 117427 N.A., 120110 Australia
Single Charger**



Part No. 117310 Battery
(sold separately)

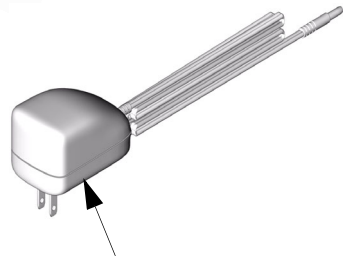

101

**Part No. 117429 N.A., 120107 Australia
Multiple Charger**

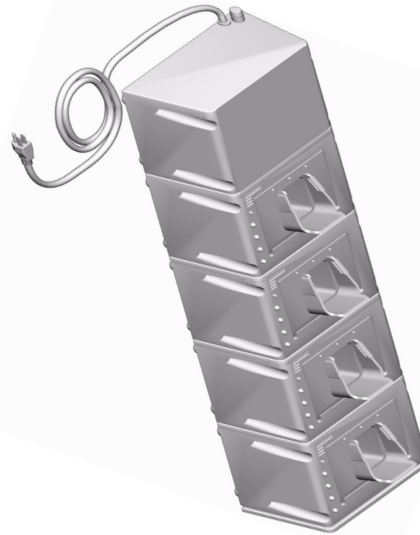

CAUTION

Do not use transformer 117430 N.A., 120107 Australia (for the single-adapter cup charger) to power transceiver. This will damage the device's board and require you to replace the device.

Part No. 117427 Single Charger

Includes:

Ref. No.	Part No.	Description	Qty.
101	117430	Transformer, power supply (N.A.)	1
	120106	Transformer, power supply (Australia)	1

Technical Data

Weights	
Single Bay Charger	2.12 lbs (0.96 kg)
Four Bay Charger	6.63 lbs (4.38 kg)
Battery	0.64 lbs (0.29 kg)
Battery	
Voltage	9.6 VDC, NiMH only
Charge Type	fast charge with pulse conditioning
Charging Time	1- 2 hours based on battery state of charge
Power Source (four-bay charger)	120 VAC (N.A.), 240 VAC (Australia)
Power Source (single-bay charger)	120 VAC to 24 VDC plug in transformer (N.A.), 240 VAC to 24 VDC plug in transformer (Australia)
Operating Temperature Range	32°F to 122°F (0° to 50°C)
Storage Humidity Range	0% - 95% relative humidity, non-condensing
Storage Temperature Range	-40°F to 185°F (-40° to 85°C)
Conformity (EMC for 120110, 120107)	ACMA (Australia)

Dimensions

Part No. 117427 N.A., 120110 Australia
Single Charger

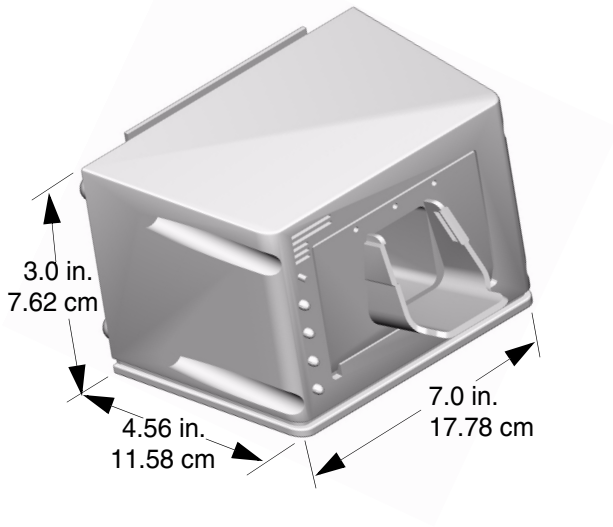

Part No. 117429 N.A., 120107 Australia
Multiple Charger

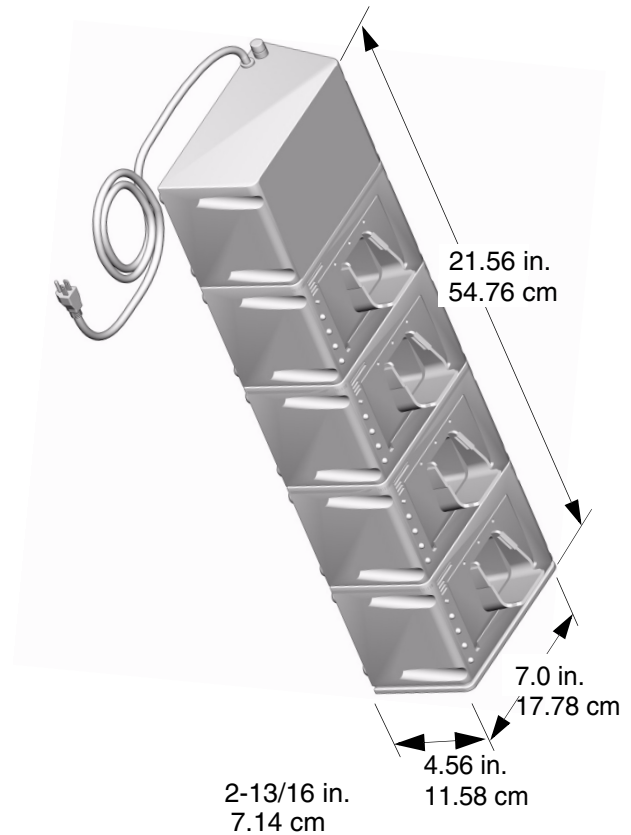

Mounting Hole Dimensions

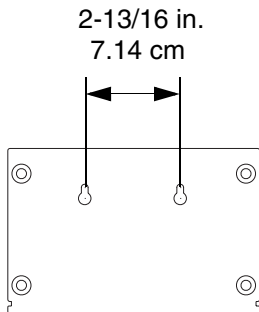

Single Charger

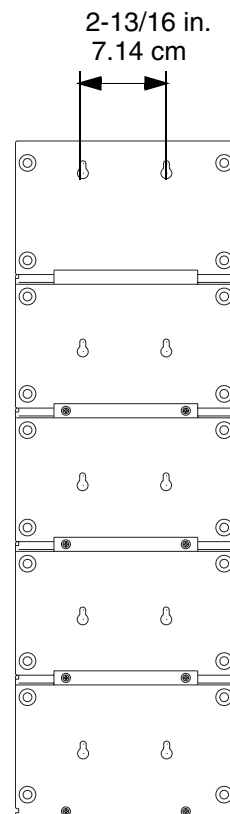

Multiple Charger

Both the single-bay charger and multiple-bay charger can be wall mounted using screws and wall anchors.

Both chargers also have rubber feet for horizontal surface mounting.

T13776



A series of horizontal lines for writing, starting from the top line and extending down to the bottom line, providing a template for text entry.

Graco Standard Warranty

Graco warrants all equipment manufactured by Graco and bearing its name to be free from defects in material and workmanship on the date of sale to the original purchaser for use. With the exception of any special, extended, or limited warranty published by Graco, Graco will, for a period of twenty-four months from the date of sale, repair or replace any part of the equipment determined by Graco to be defective. This warranty applies only when the equipment is installed, operated and maintained in accordance with Graco's written recommendations.

This warranty does not cover, and Graco shall not be liable for general wear and tear, or any malfunction, damage or wear caused by faulty installation, misapplication, abrasion, corrosion, inadequate or improper maintenance, negligence, accident, tampering, or substitution of non-Graco component parts. Nor shall Graco be liable for malfunction, damage or wear caused by the incompatibility of Graco equipment with structures, accessories, equipment or materials not supplied by Graco, or the improper design, manufacture, installation, operation or maintenance of structures, accessories, equipment or materials not supplied by Graco.

This warranty is conditioned upon the prepaid return of the equipment claimed to be defective to an authorized Graco distributor for verification of the claimed defect. If the claimed defect is verified, Graco will repair or replace free of charge any defective parts. The equipment will be returned to the original purchaser transportation prepaid. If inspection of the equipment does not disclose any defect in material or workmanship, repairs will be made at a reasonable charge, which charges may include the costs of parts, labor, and transportation.

THIS WARRANTY IS EXCLUSIVE, AND IS IN LIEU OF ANY OTHER WARRANTIES, EXPRESS OR IMPLIED, INCLUDING BUT NOT LIMITED TO WARRANTY OF MERCHANTABILITY OR WARRANTY OF FITNESS FOR A PARTICULAR PURPOSE.

Graco's sole obligation and buyer's sole remedy for any breach of warranty shall be as set forth above. The buyer agrees that no other remedy (including, but not limited to, incidental or consequential damages for lost profits, lost sales, injury to person or property, or any other incidental or consequential loss) shall be available. Any action for breach of warranty must be brought within two (2) years of the date of sale.

Graco makes no warranty, and disclaims all implied warranties of merchantability and fitness for a particular purpose in connection with accessories, equipment, materials or components sold but not manufactured by Graco. These items sold, but not manufactured by Graco (such as electric motors, switches, hose, etc.), are subject to the warranty, if any, of their manufacturer. Graco will provide purchaser with reasonable assistance in making any claim for breach of these warranties.

In no event will Graco be liable for indirect, incidental, special or consequential damages resulting from Graco supplying equipment hereunder, or the furnishing, performance, or use of any products or other goods sold hereto, whether due to a breach of contract, breach of warranty, the negligence of Graco, or otherwise.

FOR GRACO CANADA CUSTOMERS

The parties acknowledge that they have required that the present document, as well as all documents, notices and legal proceedings entered into, given or instituted pursuant hereto or relating directly or indirectly hereto, be drawn up in English. Les parties reconnaissent avoir convenu que la rédaction du présente document sera en Anglais, ainsi que tous documents, avis et procédures judiciaires exécutés, donnés ou intentés à la suite de ou en rapport, directement ou indirectement, avec les procédures concernées.

Graco Phone Numbers

TO PLACE AN ORDER, contact your Graco distributor, or call this number to identify the distributor closest to you:
Phone: 612-623-6928 or **Toll Free:** 1-800-533-9655, **Fax:** 612-378-3590

*All written and visual data contained in this document reflects the latest product information available at the time of publication.
Graco reserves the right to make changes at any time without notice.*

MM 309502

Corporate Headquarters: Minneapolis
International Offices: Belgium, Korea, China, Japan
GRACO INC. P.O. BOX 1441 MINNEAPOLIS, MN 55440-1441
www.graco.com
309502F Rev. 6/2006