

Operation



Interior Texture Sprayers **TexSpray™ RTX 750™** **and RTX 1000™**

309585C

For Water-Based Materials Only

Models:

246183, 246555 - RTX 750, 6 Gallon

55 psi (3.79 bar) Maximum Fluid Working Pressure

246184, 246556 - RTX 1000, 8 Gallon

60 psi (4.14 bar) Maximum Fluid Working Pressure



Read warnings and instructions.

Related Manuals



309584



309586

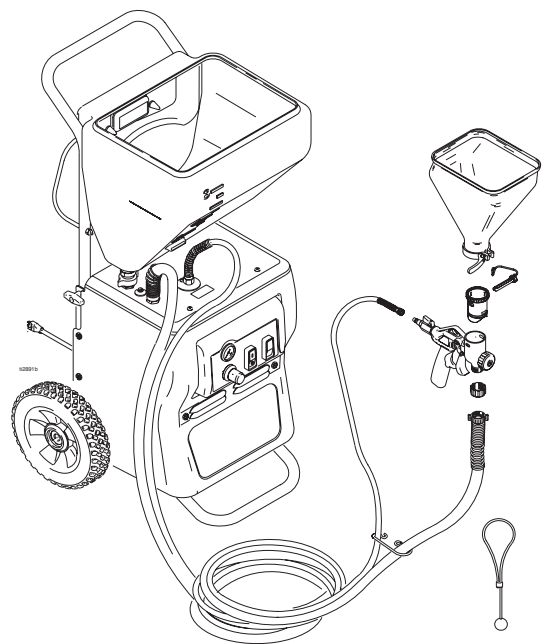

Model 246184 Shown

PROVEN QUALITY. LEADING TECHNOLOGY.



WARNINGS



Fire and Explosion Hazard

Improper grounding, poor ventilation, open flames or sparks can cause a hazardous condition and result in fire or explosion and serious injury.



- The system is for use with water-based materials only. Only use fluids compatible with the equipment. Refer to Technical Data of all equipment manuals. Read fluid and solvent manufacturers warnings.
- Ground the equipment. See **Grounding and Electrical Requirements**, page 5.
- If there is any static sparking or you feel an electric shock while using this equipment, stop spraying immediately. Do not use the equipment until you identify and correct the equipment until you identify and correct the problem.
- Keep work area free of debris, including solvent, rags and gasoline.
- Comply with all applicable state and national fire, electrical and safety regulations.



Equipment Misuse Hazard

Equipment misuse can cause equipment to rupture, malfunction, or start unexpectedly and cause serious injury.

- Before operating this equipment, read all manuals, tags, and labels including material labels and instructions.
- Do not expose system to rain. Always store system indoors.
- Do not alter or modify equipment.
- Do not spray cementitious materials.
- Do not exceed maximum working pressure of lowest rated component in your system.
- Check equipment daily. Repair or replace worn or damaged parts immediately.
- To reduce risk of serious injury, including electric shock and splashing fluid in eyes, follow **Pressure Relief Procedure** on page 5 before servicing the unit.
- Do not use hoses to pull equipment.
- Route hoses away from traffic areas, sharp edges, moving parts and hot surfaces.
- Do not expose Graco hoses to temperatures above 130 F (55 C) or below -35 F (-37 C). Store hazardous fluid in an approved container. Dispose of hazardous fluid according to all local, state and national guidelines.
- Never directly inhale compressed air. Compressed air may contain toxic vapors.

WARNINGS	
	<p>Electric Shock Hazard To reduce the risk of electric shock:</p> <ul style="list-style-type: none"> • Be sure sprayer is adequately grounded through electrical outlet. • Use only 3-wire, extension cords. • Make sure ground prongs are intact on sprayer and extension cords. Improper installation of grounding plug will result in a risk of electrical shock, fire or explosion that could cause serious injury or death. • Do not operate with cover removed. • Turn off sprayer. Follow Pressure Relief Procedure, page 5, and unplug unit, before removing any parts. •
	<p>Pressurized Equipment Hazard Fluid from gun, leaks or ruptured components can splash in the eyes or on skin and cause serious injury.</p> <ul style="list-style-type: none"> • Follow Pressure Relief Procedure, page 5 when you stop spraying and before cleaning, checking or servicing. • Do not point spray gun at anyone; put hand, fingers or rag over nozzle, or stop or deflect leaks with your hand, body, glove, or rag. • Wear protective clothing, gloves, and eyewear.
	<p>Cleaning Solvent Hazard with Plastic Parts Use only compatible water-based solvents to clean plastic structural or pressure-containing parts. Many solvents can degrade plastic parts to the point where they could fail. Such failure could cause serious injury or property damage. See Technical Data on page 15 of this instruction manual and in all other equipment manuals. Read fluid and solvent manufacturer's warnings.</p>

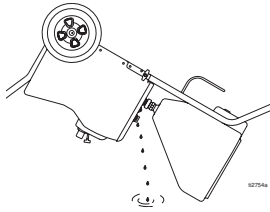
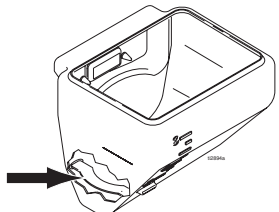
CAUTION	
	<ul style="list-style-type: none"> •Water or material remaining in unit when temperatures are below freezing can damage motor and/or delay pump startup. Do not allow unit to freeze. <p>To insure water and material are completely drained out of unit:</p> <ol style="list-style-type: none"> 1. Remove material line from sprayer. 2. Tip sprayer up as shown. <ul style="list-style-type: none"> •Before adding material or starting unit in cold weather, run warm water through pump.
	<p>Before adding material to hopper, install burp guard. When only a small amount of material remains in the hopper, the burp guard prevents material from shooting out when the unit is turned off. This material could splash in the operator's eyes or on skin, or into the air.</p>

Component Identification

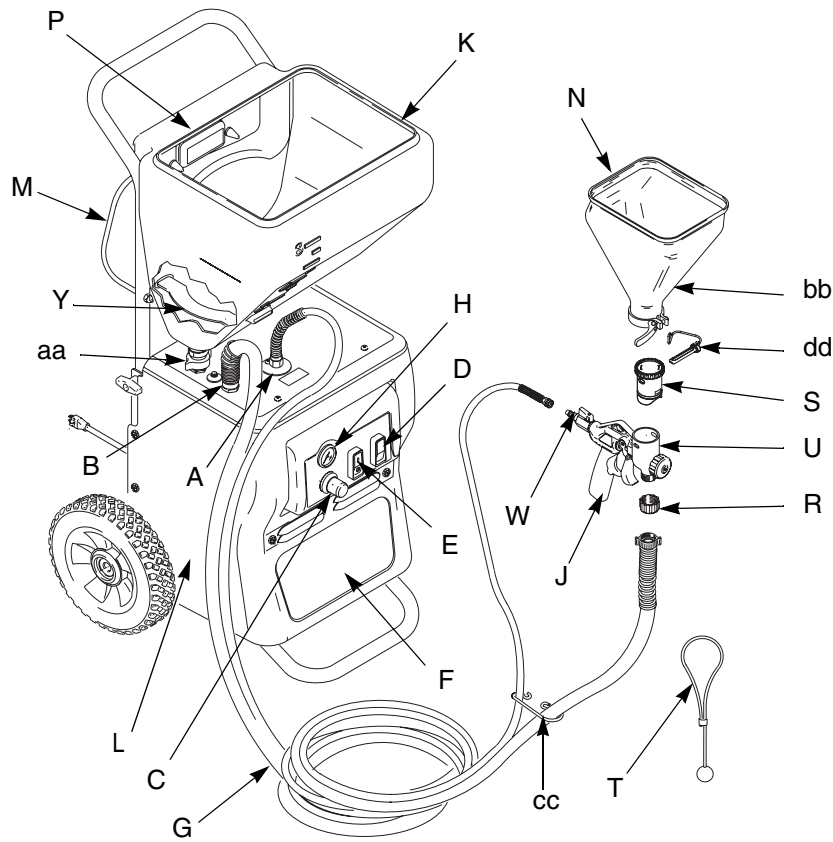

Item	Component	Item	Component
A	Air hose outlet	N	Touch-up hopper (3/4 gallon)
B	Material hose outlet	P	Nozzle storage
C	Material flow control (RTX 1000)	R	Hose plug
D	Hopper gun/spray gun selector switch	S	Gun plug
E	ON/OFF switch	T	Material thickness gauge
F	Air Compressor (inside)	U	Nozzle (Nozzle Selection, page 10)
G	Material/air hose	W	Gun air valve
H	Material flow indicator (RTX 1000)	Y	Burp guard
J	Texture spray gun (manual 309584)	aa	Hopper fitting (fluid inlet)
K	Material Hopper - 6 gallon, RTX 750 Material Hopper - 8 gallon, RTX 1000	bb	Hopper clamp
L	RotoFlex™ pump (inside)	cc	Hose clip
M	Hose rack/cord wrap	dd	Gun plug clip

Preparation

Pressure Relief Procedure



To reduce risk of injury, follow this procedure whenever you see this symbol throughout this manual, Also, perform this procedure whenever you:

- stop spraying.
- check or repair any part of this system.
- install or clean spray nozzle.



WARNING



page 2

1. Turn Power Switch OFF.

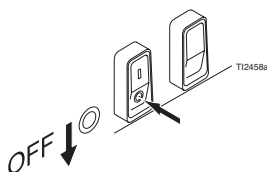

2. Trigger gun into material hopper.

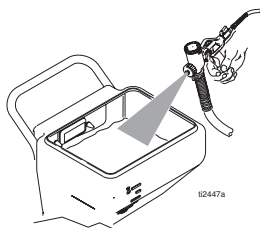

3. Open gun air valve.

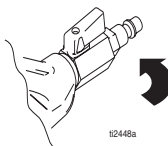

Grounding and Electrical Requirements

This sprayer must be grounded. Grounding reduces the risk of electrical shock by providing an escape wire for the electrical current. The sprayer cord includes a grounding wire with an appropriate grounding plug. The plug must be plugged into an outlet that is properly installed and grounded in accordance with all local codes and ordinances.

Check with a qualified electrician or serviceman if grounding instructions are not completely understood, or if in doubt as to whether the product is properly grounded. Do not modify plug provided; if it will not fit the outlet, have proper outlet installed by a qualified electrician.



WARNING



page 2

120V AC Systems

- This equipment requires a 120V AC, 60 Hz, 15A circuit with a grounding receptacle. Do not use an adapter with this product.

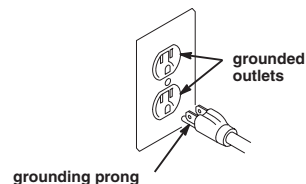

Extension Cords

- Use only an extension cord with an undamaged, 3-prong plug.
- For 25 to 50 ft (7.6 to 15.2 m) cords, use 3-wire, 14 AWG (1.5 mm²) minimum.
- For up to 100 ft. (30.48 m) cord, use 3-wire, 12 AWG (2.5 mm²) minimum.

Auxiliary Air Compressor

Do not use an auxiliary air compressor with this spray system.

Generator Requirements

3500 W (3.5 kW) minimum.

Hose Size and Length

The system comes with a hose set consisting of a 3/4 in. ID x 25 ft (25 mm x 7.6 m) material hose and a 3/8 in-ID air hose.

Do not use more than 25 ft (7.6 m) of material hose.



CAUTION

Air hose fittings can get hot! Allow sprayer to cool down 15 minutes before removing air hose.

Setup

Important

- If you are going to stop spraying for more than 5 minutes, turn sprayer off to prevent shortened pump hose life.
- Do not allow material to dry inside pump, hoses, gun or spray system.

WARNING page 2.

Texture Spraying (6-8 gallon material hopper)

- When using material hopper, insert the Gun Plug in the top of the gun. Make sure both plug tabs are securely snapped into place. Hose plug must be removed from bottom of gun.

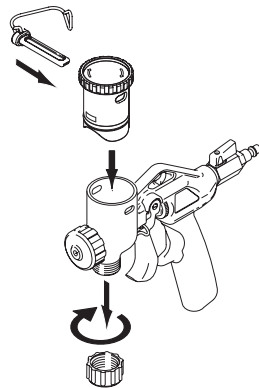

1. Connect air hose and material hose to sprayer air and material hose outlets.

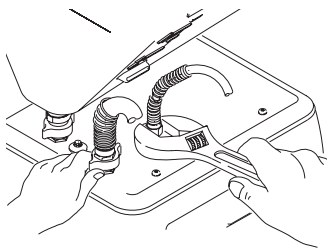

2. Connect air hose to gun.

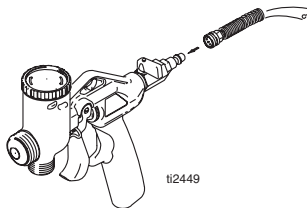

3. Open air valve.

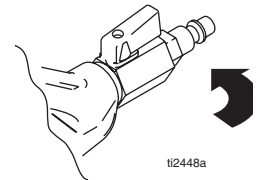

4. Connect material hose to gun.

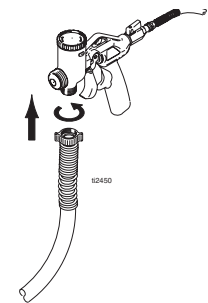

5. Install spray nozzle. See Recommended Nozzle Selection Chart, Page 10.

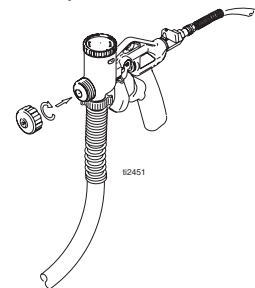

6. Fill material hopper with 1 gallon of water.

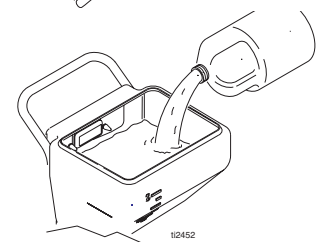

7. Turn hopper gun/spray gun selector switch to SPRAY GUN.

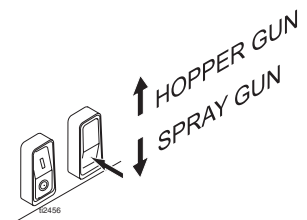

8. Turn power switch ON.

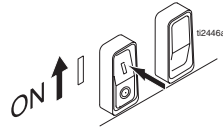

9. Close gun air valve.

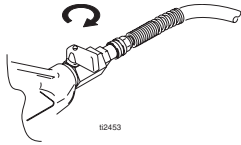

10. Point gun into waste bucket and pull trigger to pump water through the system. Continue to trigger gun until material hopper is empty.

11. Install burp guard. Caution, page 3.

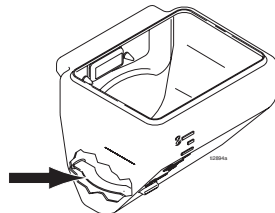

12. Add pre-mixed texture mix to material hopper. See Mixing Material, page 9.

13. Continue to trigger gun and spray into waste bucket until a steady stream of material sprays out of gun.

14. Release trigger. To achieve uniform spray pattern, adjust air valve and flow adjustment nut on gun. If you do not achieve the desired pattern, change nozzles, page 10.

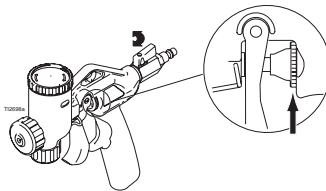

- Fluid flow will be restricted if the material hose is kinked.

15. For RTX 1000 model: when using a thicker texture:

- Turn material flow control knob clockwise to increase material flow.
- If you want more control when spraying splatter or orange peel, turn the control knob counter-clockwise to decrease material flow.

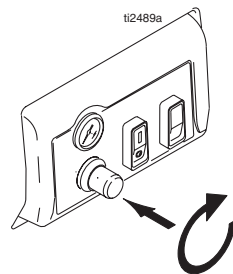

Touch Up Hopper Attachment



- The Hose Plug must be securely fastened to bottom of gun when using the Touch Up Hopper. Gun plug must be removed from top of gun.

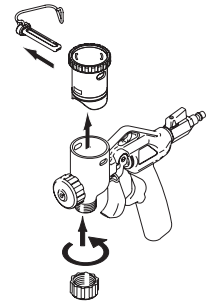

- Connect air hose to sprayer.
- Connect air hose to gun.
- Clip material hose to air hose.

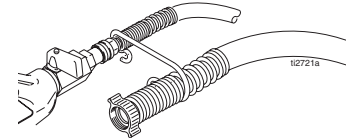

- Slide hopper on top of gun, and tighten clamp.
- Install spray nozzle. Page 10.

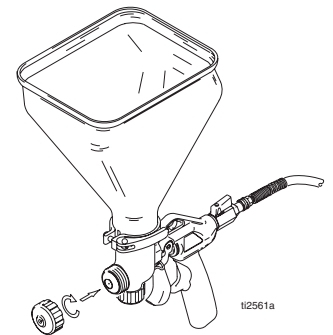

- Fill Touch-up hopper with pre-mixed texture. See Mixing Material, page 9.

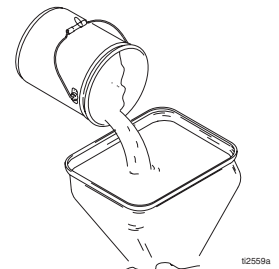

7. Turn hopper gun/spray gun selector switch to HOPPER GUN.

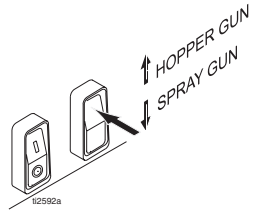

CAUTION

Failure to change selector switch to Hopper Gun when using hopper gun will damage pump hose.

8. Open gun air valve.

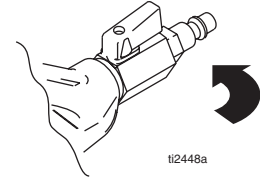

9. Turn power switch ON.

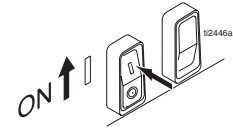

10. To achieve uniform spray pattern, adjust air valve and flow adjustment nut on gun. If you do not achieve the desired spray pattern, change nozzles, page 10.

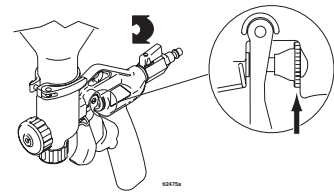

Mixing Material

 Correct material mixture is essential. The pump will not operate if the mixture is too thick.

Mix the material in a separate container before pouring it into hopper.

Use Material Thickness Gauge to determine mixture is thin enough to spray.

*The Material Thickness Gauge will only determine if the material is thin enough to pass through the pump. For some applications or for higher speed spraying, your mixture may need to be thinner.

Dry Mix - 40 lb (18 kg) bag.

 For best results do not use partial bags of material.

1. Slowly add one 40 lb. (18 kg) bag of texture material to 5-6 gallons (18.9-22.7 liters) of clean water as instructed on the bag instructions.



2. Agitate to mix, using a half-inch, variable speed drill with mixing paddle, to a smooth, lump-free consistency.



3. Allow ceiling texture to set for at least 15 minutes. Then remix prior to use.

4. After texture material is thoroughly mixed, gently set ball end of Material Thickness Gauge on surface of mixture.

 For an accurate test, be sure gauge is completely dry and clean every time it is used.

5. Observe the ball on the material. When the material is thin enough to spray the ball will sink completely into the mixture.

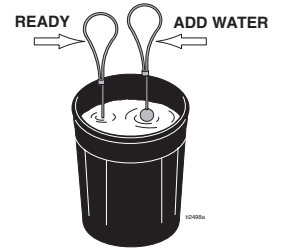

6. If the ball does not sink completely into the mixture within 10 seconds, add more water, agitate and try test again.

Premix

1. Slowly add approximately 2 to 4 qts (1.9 to 3.8 liters) of water to a 5 gallon (18.9 liter) bucket of premix.



2. Agitate to mix, using a half-inch, variable speed drill with a mixing paddle, to a smooth, lump-free consistency.

3. After texture material is thoroughly mixed, gently set ball end of Material Thickness Gauge on surface of mixture.

 For an accurate test, be sure gauge is completely dry and clean every time it is used.

4. Observe the ball in material. When the material is thin enough to spray the ball will sink completely into the mixture.

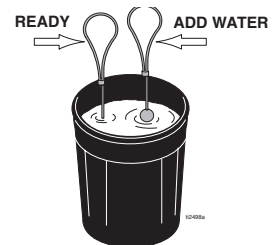

5. If the ball does not sink completely into the mixture within 10 seconds, add more water, agitate and try test again.

Spray Techniques

Recommended Nozzle Selection Chart

Application	Nozzle Size ²	Air Volume ¹
Simulated Acoustic	6 mm, white <i>(fine to medium)</i> 8 mm, gray <i>(coarse)</i>	medium to high
Orange peel	4 mm, beige, 6 mm, white	medium to high
Splatter coat	6 mm, white 8 mm, gray	low to medium
Knockdown	8 mm, gray 12 mm, black	low

¹Control air volume with gun air valve.

²For more material volume try a larger nozzle.

Adjusting the System

Sufficient fluid output (volume and pressure) and good atomization is a balance of atomizing air, material thickness/material flow and nozzle selection. Achieving the correct balance for your application requires experimentation to achieve desired results. Keep in mind these important points when adjusting gun:

- Select proper nozzle for your application. See Nozzle Selection Chart. Remember, the larger the nozzle, the heavier the pattern.
- Start sprayer with gun air flow valve completely open. If needed, slowly close gun air flow until you get a good spray pattern. Use minimum amount of air at spray gun to achieve proper spray pattern and to minimize bounce back.
 - + Test spray pattern on cardboard. Hold gun 18 to 24 in. (45.7 to 60.9 cm) from surface. Use this spraying distance for most applications.
- Air and material flow adjustments are made at the gun on all units. The RTX1000 model allows material flow adjustment at the sprayer also.
 - + Opening air valve increases air flow through gun, which decreases texture material flow through pump.
 - + Closing air valve decreases air flow through gun, which increases texture material flow through pump.

To Get Less Material

Try one or a combination of these methods:

- Open air valve.
- Turn gun flow adjustment nut to decrease flow, counter-clockwise.
- Use smaller nozzle.
- RTX 1000 model: decrease Material Flow Control.

To Get More Material

Try any one or a combination of these methods:

- Close air valve.
- Turn gun flow adjustment nut to increase flow, clockwise.
- Use thinner material mixture.
- Use a larger nozzle.
- RTX1000 model: increase Material Flow Control.

Preventing Material Surge at Gun Trigger

Pressure will build up in the system when you stop triggering the gun. To prevent material surge at initial gun triggering:

- Point gun away from surface you are spraying when you first pull trigger.
- When you first start to spray, hold the gun away from the surface and gradually work your way closer to it.
- Keep gun moving.
- After you begin spraying, trigger the gun as little as possible.

For Continuous Spraying

Use trigger lock to hold trigger open and reduce fatigue.

Check Material Consistency Periodically

Check and thin material as needed to maintain proper consistency. The material may thicken as it sits and slow down production. Agitate periodically.

Shutdown and Cleanup

 Keep pump and hose clean when switching between simulated acoustic, knockdown and orange peel applications. A dirty pump can release particles of texture into the finish.

CAUTION	
<ul style="list-style-type: none"> • Turn off sprayer if you are going to stop spraying for 5 minutes or longer. • Before removing material hose be sure pressure is relieved and material is not in hose. • To keep unit in good operating condition, always clean it thoroughly and prepare it properly for storage. 	

WARNING	
	page 2, 5.

Texture Spraying (6-8 gallon Material Hopper)

When you have finished spraying:

1. Open gun air valve.

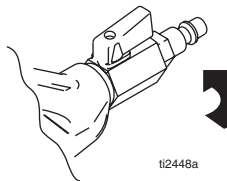

2. Turn hopper gun/spray gun selection switch to SPRAY GUN.

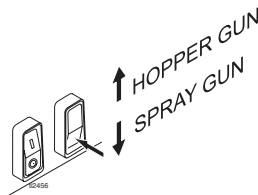

3. Turn power switch ON.

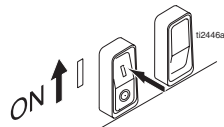

4. Close gun air valve.

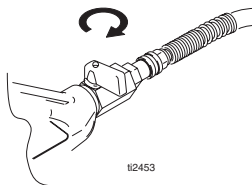

5. Trigger gun into bucket until most of texture mix is pumped out.
6. Fill material hopper with 2-4 gallons of clean water.
7. Spray inside material hopper to circulate water through gun and hose. While circulating water, use gun to clean material hopper.
8. Partially open gun air valve to use air to achieve better cleaning results.
9. Spray water into a waste bucket to empty material hopper.

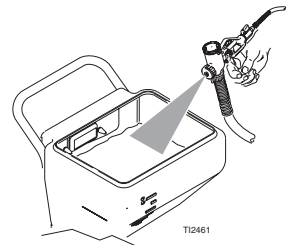

 A soft brush can be used to loosen dried on material.

10. Turn power switch OFF.
11. Open gun air valve. **Relieve Pressure**, page 5.

CAUTION	
If water freezes in unit damage may occur. In cold weather store system where it will not freeze.	

Removing Material Hopper from Sprayer

The material hopper can be removed for cleaning. To remove material hopper:

1. Loosen bottom fitting.
2. Lift material hopper straight up, off unit.
3. Plug opening on bottom of material hopper with your hand.
4. Take hopper to cleaning area.

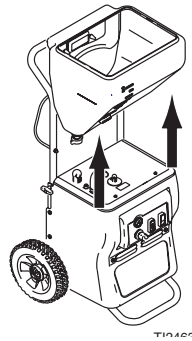
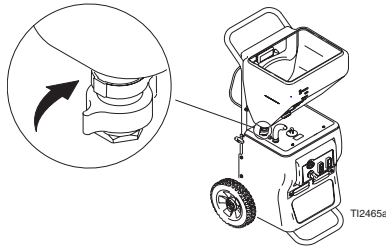

3. Plug opening on bottom of material hopper with your hand.
4. Take hopper to cleaning area.

To reassemble:

1. Place material hopper on sprayer, aligning fitting to sprayer.
2. Hand tighten fitting.

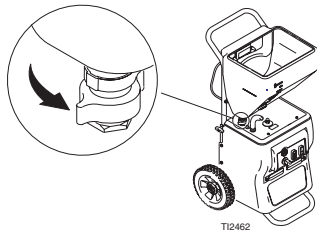

Touch-up Hopper Attachment

When you have finished spraying

1. Shut off compressor. Disconnect air line from gun.
2. Drain material into a bucket until most of the texture material is out of hopper.

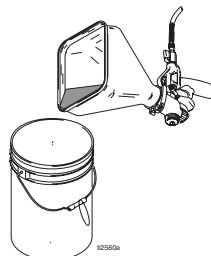

3. Fill hopper with clean water. Remove nozzle from gun and allow water to flow through and out of gun.
4. Flush until gun is clean
5. Turn power switch ON.
6. Open gun air valve.
7. Trigger gun to blow air through tip, clearing out any remaining material.
8. Remove hopper from gun and finish cleaning all components. A soft brush may be used to help loosen any dried on material from surface.



Be sure to keep air passages in needle clean and free of material.

To improve working condition for future use, after cleaning, apply a few drops of light oil to:

- air hose quick disconnect
- material hose connections
- flow adjustment on gun

Transporting the Sprayer

The handle and hopper can be removed from the sprayer for storage or transporting.

To remove hopper from sprayer, follow the procedure described on page 12.

To remove the handle:

1. Loosen the two (2) wing-nut screws on either side of the handle.
2. Squeeze the handle together.
3. Remove.

Troubleshooting



Pressure Relief, page 5

Problem	Cause	Solution
Sprayer won't run	Power switch not on	Turn switch on.
	No power at wall outlet	Check outlet by plugging in another appliance. If appliance does not work, try another outlet.
	Wrong size generator	Use a 3500 watt or larger generator. Refer to Generator Requirements, page 5
	Too many items on same circuit	Unplug other items from circuit
	Extension cord too long or wrong gauge	Use a different extension cord. Refer to Grounding and Electric Requirements, page 5
	Breaker tripped	Reset breaker
Pump won't pump material	Air lock	Open air valve on gun
	Selector switch in wrong position	Move selector switch to correct position for application
	Mix too thick	Add water to thin material. Use Material Thickness Gauge.
	Loose fittings	Check and retighten all fittings
	Plugged gun	Relieve Pressure , page 5. Remove gun from hose. Clean gun.
	Pump hose worn out	Replace hose. Recommended hose replacement - every 2000-2500 gallons.
	Pump cold	Move pump to warm room and allow it to warm up or run hot water through sprayer.
Material runs out of bottom of sprayer	Pump hose worn out	Replace hose
	Loose fittings	Check and retighten all fittings
No air from compressor	Gun air valve closed	Open gun air valve
	Low voltage	Check extension cord length and gauge. Replace if different than recommended. Refer to Grounding and Electrical Requirements, page 5.
	Gun needle plugged	Clean needle and retry.
	Worn compressor	Replace compressor. Contact a qualified Graco Service Center.
	Lines not connected	Check all quick disconnect connections to gun and hoses
	Damaged hose	Replace hose

Problem	Cause	Solution
Speed of application slow or slower	Material too thick	Thin material.
	Nozzle too small	Change nozzles to a larger size. See Recommended Nozzle Selection Chart, page 10.
	Too much air being used.	Partially close gun air valve to reduce air flow.
	Flow control (RTX 1000 model) set too low	Increase flow control setting
	Pump hose worn	Replace hose.
	Plugged or dirty gun	Relieve Pressure , page 5. Clean gun.
	Kinked hose	Unkink hose.
	Gun adjustment set too low	Increase flow adjustment with flow adjustment nut.
Intermittent flow/sputtering	Hopper connection not tight	Check gasket. Tighten connection.
	Debris in system	Clean
Quick disconnect does not stay connected.	Dirty or corroded fitting	Clean thoroughly. Soak in oil. Apply a few drops of light oil.
Gun will not shut off	Worn nozzle or needle.	Relieve Pressure , page 5. Replace worn parts.
	Debris in needle passage	Relieve Pressure , page 5. Clean.
Fluid leaking at Flow Adjustment Nut	Damaged seal.	Relieve Pressure , page 5. Replace seal.
Fluid leaking out of either plug	Missing or damaged o-rings	Relieve Pressure , page 5. Replace o-rings.
	Gun damaged	Replace gun
Needle adjustment won't adjust	Dirty threads	Clean threads
	Nozzle not on gun	Put nozzle on gun

Technical Data

Main unit power requirements	120 Vac, 60 Hz, 15A, 1 phase
Maximum fluid working pressure	60 psi, (4.137 bar)
Maximum air working pressure	45 psi (3.10 bar)
Compressor specifications	Universal motor thermally protected, oil-less
Compressor air displacement	4.5 displacement scfm at 30 psi
Generator required	3500W minimum
Electric Motor	
Material motor	Capacitor start AC 2.8A/1/3 hp AC, open frame
Compressor motor	Universal AC 10.5A
Power Cord	16 AWG, 3-wire, 25 ft
Material hopper capacity	Model 246183: 6 gallons Model 246184: 8 gallons
	Gun material hopper: 3/4 gallon
Maximum delivery with texture	1 to 1.5 gpm (3.8 to 5.7 lpm)
Dimensions: RTX 750	
Length	23 in. (584 mm) with handle
Width	24 in. (610 mm)
Height	40 in. (1016 mm)
Weight	75 lb (34 kg)
Dimensions: RTX 1000	
Length	23 in. (584 mm) with handle
Width	24 in. (610 mm)
Height	40 in. (1016 mm)
Weight	80 lb (36 kg)
Wetted parts	brass, aluminum, plastic
Sound data	
Sound pressure level*	83.2 dB(A)
Sound power level**	97.5 dB(A)
Storage Temperature Range	35°F - 160°F (1.6°C - 71°C)
Operating Temperature Range	40°F - 115°F (4°C - 46°C)
Gun:	
Maximum Working Pressure	60 psi (4.137 bar)
Air Maximum Working Pressure	100 psi (6.895 bar)
CFM Rating	3.5 - 11 CFM
Weight	1.1 lb (500 g)

*Measured while spraying at 1 m.

**Measured per ISO-3744

Graco Warranty

Graco warrants all equipment referenced in this document which is manufactured by Graco and bearing its name to be free from defects in material and workmanship on the date of sale to the original purchaser for use. With the exception of any special, extended, or limited warranty published by Graco, Graco will, for a period of twelve months from the date of sale, repair or replace any part of the equipment determined by Graco to be defective. This warranty applies only when the equipment is installed, operated and maintained in accordance with Graco's written recommendations.

Graco warrants all equipment referenced in this document which is manufactured by Graco and bearing its name to be free from defects in material and workmanship on the date of sale by an authorized Graco distributor to the original purchaser for use. With the exception of any special, extended, or limited warranty published by Graco, Graco will, for a period of twelve months from the date of sale, repair or replace any part of the equipment determined by Graco to be defective. This warranty applies only when the equipment is installed, operated and maintained in accordance with Graco's written recommendations.

This warranty does not cover, and Graco shall not be liable for general wear and tear, or any malfunction, damage or wear caused by faulty installation, misapplication, abrasion, corrosion, inadequate or improper maintenance, negligence, accident, tampering, or substitution of non-Graco component parts. Nor shall Graco be liable for malfunction, damage or wear caused by the incompatibility of Graco equipment with structures, accessories, equipment or materials not supplied by Graco, or the improper design, manufacture, installation, operation or maintenance of structures, accessories, equipment or materials not supplied by Graco.

This warranty is conditioned upon the prepaid return of the equipment claimed to be defective to an authorized Graco distributor for verification of the claimed defect. If the claimed defect is verified, Graco will repair or replace free of charge any defective parts. The equipment will be returned to the original purchaser transportation prepaid. If inspection of the equipment does not disclose any defect in material or workmanship, repairs will be made at a reasonable charge, which charges may include the costs of parts, labor, and transportation.

THIS WARRANTY IS EXCLUSIVE, AND IS IN LIEU OF ANY OTHER WARRANTIES, EXPRESS OR IMPLIED, INCLUDING BUT NOT LIMITED TO WARRANTY OF MERCHANTABILITY OR WARRANTY OF FITNESS FOR A PARTICULAR PURPOSE.

Graco's sole obligation and buyer's sole remedy for any breach of warranty shall be as set forth above. The buyer agrees that no other remedy (including, but not limited to, incidental or consequential damages for lost profits, lost sales, injury to person or property, or any other incidental or consequential loss) shall be available. Any action for breach of warranty must be brought within two (2) years of the date of sale.

GRACO MAKES NO WARRANTY, AND DISCLAIMS ALL IMPLIED WARRANTIES OF MERCHANTABILITY AND FITNESS FOR A PARTICULAR PURPOSE, IN CONNECTION WITH ACCESSORIES, EQUIPMENT, MATERIALS OR COMPONENTS SOLD BUT NOT MANUFACTURED BY GRACO. These items sold, but not manufactured by Graco (such as electric motors, switches, hose, etc.), are subject to the warranty, if any, of their manufacturer. Graco will provide purchaser with reasonable assistance in making any claim for breach of these warranties.

In no event will Graco be liable for indirect, incidental, special or consequential damages resulting from Graco supplying equipment hereunder, or the furnishing, performance, or use of any products or other goods sold hereto, whether due to a breach of contract, breach of warranty, the negligence of Graco, or otherwise.

TO PLACE AN ORDER OR FOR SERVICE, contact your Graco distributor,
or call 1-800-690-2894 to identify the nearest distributor.

All written and visual data contained in this document reflects the latest product information available at the time of publication.

Graco reserves the right to make changes at any time without notice.

This manual contains English: MM 309585

Sales Offices: Minneapolis

International Offices: Belgium, Korea, China, Japan

PRINTED IN USA 12/2002, Rev 3/2006