

# Instructions - Parts



## Important Safety Instructions.

Read all warnings and instructions in this manual.  
Save these instructions.

20 Liter (5 Gallon) Pail Size

# Therm-O-Flow 20<sup>®</sup>

312094 rev.A

## EasyKey™ Hot Melt Pail Unloaders

*For applying hot melt sealant and adhesive materials.*

*Maximum Operating Temperature: 400°F (204°C)*

*Maximum System Air Supply Pressure: 100 psi (0.7 MPa, 7 bar)*

### President Powered Unloader

*1800 psi (12.6 MPa, 126 bar) Maximum Fluid Working Pressure*

*100 psi (0.7 MPa, 7 bar) Maximum Air Motor Pressure*

See page 2 for **Contents** and page 5 for **Model Numbers**.

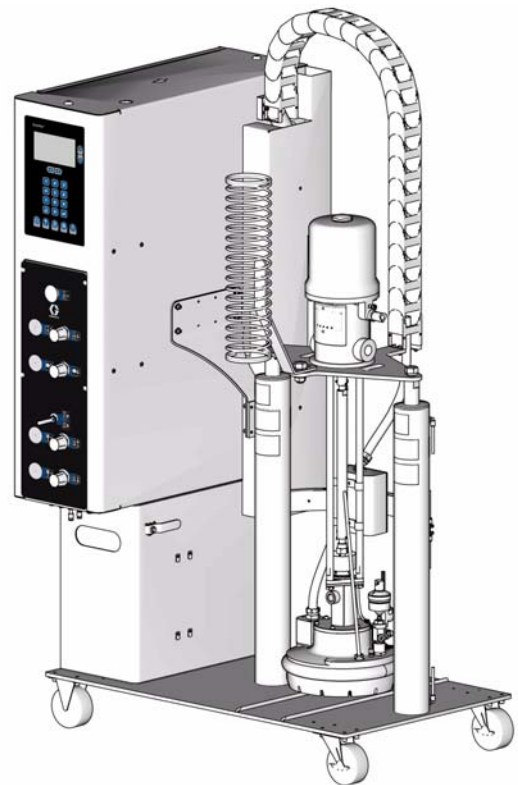

TI10024A

PROVEN QUALITY. LEADING TECHNOLOGY.









# Contents

<b>Warnings</b> .....	<b>3</b>	<b>Dual Ram Cross-Over Installation</b> .....	<b>31</b>
<b>Overview</b> .....	<b>5</b>	Typical Installation .....	31
How the Therm-O-Flow 20 Works .....	5	<b>Maintenance</b> .....	<b>32</b>
Model Numbers .....	5	Ram .....	32
Component Identification .....	6	Ground Fault Interrupt .....	32
Power Requirements .....	8	Power in a Tandem System .....	32
Heat Control Zone Selection .....	8	Resetting the Ground Fault Interrupt .....	32
<b>Installation</b> .....	<b>9</b>	<b>Alarm Troubleshooting</b> .....	<b>32</b>
Unpacking .....	9	<b>Ram Troubleshooting</b> .....	<b>34</b>
Location Requirements .....	9	<b>Pump Troubleshooting</b> .....	<b>35</b>
Locate and Install the Ram .....	9	<b>Air Motor Troubleshooting</b> .....	<b>35</b>
Mechanical Setup .....	10	<b>Electrical Control Panel Troubleshooting</b> .....	<b>36</b>
Electrically Connect Hoses .....	10	<b>Service</b> .....	<b>38</b>
Connect the Electrical Control Panel to a Power Source .....	10	Ram .....	38
Grounding .....	11	Pump .....	38
Check Resistance .....	12	Ground Fault interrupt .....	38
Overview of the Temperature Controller Settings	13	Power in a Tandem System .....	38
Purging the System .....	13	Platen Service .....	38
<b>Operator Controls</b> .....	<b>14</b>	Air Motor/Pump Removal and Service .....	40
Main Power Disconnect .....	14	<b>Parts</b> .....	<b>42</b>
EasyKey Display and Keypad .....	14	Therm-O-Flow 20 .....	42
LCD Display .....	15	Pump .....	44
Alarm .....	15	Platen .....	45
<b>EasyKey Display Screens</b> .....	<b>16</b>	Air Control .....	46
Power Up Screens .....	16	EasyKey Assembly, Part No. 255224 .....	47
Run Screens .....	16	Spare Parts and Kits .....	48
Setup Mode .....	17	<b>Electrical Schematics</b> .....	<b>49</b>
<b>Setup</b> .....	<b>22</b>	<b>Accessories</b> .....	<b>53</b>
Purge Before Using Equipment .....	22	Light Tower Kit (253547) .....	53
Set Values on EasyKey .....	22	Pail Low and Empty Sensor Kit (255233) .....	55
Material Loading .....	22	Ethernet Kit (253566) .....	56
System Heat Up .....	24	EasyKey Modbus / TCP Wiring Diagram .....	62
Prime System .....	24	Maintenance Call Kit (253548) .....	63
<b>Operation</b> .....	<b>26</b>	Discrete I/O Kit (253567) .....	65
Pressure Relief Procedure .....	26	Swirl Kit, Part No. 253263 .....	67
Trigger Lock .....	26	<b>Dimensions</b> .....	<b>68</b>
Ram Pressure Relief Procedure .....	27	<b>Technical Data</b> .....	<b>69</b>
Pail Changing .....	28	<b>Graco Standard Warranty</b> .....	<b>70</b>
System Shutdown .....	30	<b>Graco Information</b> .....	<b>70</b>

# Warnings

The following warnings are for the setup, use, grounding, maintenance, and repair of this equipment. The exclamation point symbol alerts you to a general warning and the hazard symbol refers to procedure-specific risk. Refer back to these warnings. Additional, product-specific warnings may be found throughout the body of this manual where applicable.

 <b>WARNING</b>	
	<p><b>BURN HAZARD</b></p> <p>Equipment surfaces and fluid that's heated can become very hot during operation. To avoid severe burns, do not touch hot fluid or equipment. Wait until equipment/fluid has cooled completely.</p>
	<p><b>SPLATTER HAZARD</b></p> <p>During blow off of platen splatter may occur.</p> <ul style="list-style-type: none"> <li>• Use minimum pail removal air pressure.</li> </ul>
	<p><b>MOVING PARTS HAZARD</b></p> <p>Moving parts can pinch or amputate fingers and other body parts.</p> <ul style="list-style-type: none"> <li>• Keep clear of moving parts.</li> <li>• Do not operate equipment with protective guards or covers removed.</li> <li>• Pressurized equipment can start without warning. Before checking, moving, or servicing equipment, follow the <b>Pressure Relief Procedure</b> in this manual. Disconnect power or air supply.</li> </ul>
	<p><b>ELECTRIC SHOCK HAZARD</b></p> <p>Improper grounding, setup, or usage of the system can cause electric shock.</p> <ul style="list-style-type: none"> <li>• Turn off and disconnect power at main switch before disconnecting any cables and before servicing equipment.</li> <li>• Connect only to grounded power source.</li> <li>• All electrical wiring must be done by a qualified electrician and comply with all local codes and regulations.</li> </ul>
	<p><b>TOXIC FLUID OR FUMES HAZARD</b></p> <p>Toxic fluids or fumes can cause serious injury or death if splashed in the eyes or on skin, inhaled, or swallowed.</p> <ul style="list-style-type: none"> <li>• Read MSDS's to know the specific hazards of the fluids you are using.</li> <li>• Store hazardous fluid in approved containers, and dispose of it according to applicable guidelines.</li> </ul>
	<p><b>EQUIPMENT MISUSE HAZARD</b></p> <p>Misuse can cause death or serious injury.</p> <ul style="list-style-type: none"> <li>• Do not exceed the maximum working pressure or temperature rating of the lowest rated system component. See <b>Technical Data</b> in all equipment manuals.</li> <li>• Use fluids and solvents that are compatible with equipment wetted parts. See <b>Technical Data</b> in all equipment manuals. Read fluid and solvent manufacturer's warnings. For complete information about your material, request MSDS from distributor or retailer.</li> <li>• Check equipment daily. Repair or replace worn or damaged parts immediately with genuine Graco replacement parts only.</li> <li>• Do not alter or modify equipment.</li> <li>• For professional use only.</li> <li>• Use equipment only for its intended purpose. Call your Graco distributor for information.</li> <li>• Route hoses and cables away from traffic areas, sharp edges, moving parts, and hot surfaces.</li> <li>• Do not kink or over bend hoses or use hoses to pull equipment.</li> <li>• Keep children and animals away from work area.</li> <li>• Do not operate when fatigued or under the influence of drugs or alcohol.</li> <li>• Comply with all applicable safety regulations.</li> </ul>

**WARNING**
**PERSONAL PROTECTIVE EQUIPMENT**

You must wear appropriate protective equipment when operating, servicing, or when in the operating area of the equipment to help protect you from serious injury, including eye injury, inhalation of toxic fumes, burns, and hearing loss. This equipment includes but is not limited to:

- Protective eyewear.
- Clothing and respirator as recommended by the fluid and solvent manufacturer.
- Gloves.
- Hearing protection.

**SKIN INJECTION HAZARD**

High-pressure fluid from gun, hose leaks, or ruptured components will pierce skin. This may look like just a cut, but it is a serious injury that can result in amputation. **Get immediate surgical treatment.**

- Do not point gun at anyone or at any part of the body.
- Do not put your hand over the spray tip.
- Do not stop or deflect leaks with your hand, body, glove, or rag.
- Do not spray without tip guard and trigger guard installed.
- Engage trigger lock when not spraying.
- Follow **Pressure Relief Procedure** in this manual, when you stop spraying and before cleaning, checking, or servicing equipment.

**FIRE AND EXPLOSION HAZARD**

Flammable fumes, such as solvent and paint fumes, in **work area** can ignite or explode. To help prevent fire and explosion:

- Use equipment only in well ventilated area.
- Eliminate all ignition sources; such as pilot lights, cigarettes, portable electric lamps, and plastic drop cloths (potential static arc).
- Keep work area free of debris, including solvent, rags and gasoline.
- Do not plug or unplug power cords, or turn power or light switches on or off when flammable fumes are present.
- Ground equipment and conductive objects in work area. See **Grounding** instructions.
- Use only grounded hoses.
- Hold gun firmly to side of grounded pail when triggering into pail.
- If there is static sparking or you feel a shock, **stop operation immediately**. Do not use equipment until you identify and correct the problem.
- Keep a fire extinguisher in the work area.

# Overview

## How the Therm-O-Flow 20 Works Model Numbers

A heated platen melts the sealant or adhesive and directs the molten material to the pump inlet. The material then travels through a Mini-5 pump and heated fluid moves to the application tool.

The six digit part number stamped on your Therm-O-Flow 20 defines your machine. Each digit represents a component, as shown in the following table.

1. Therm-O-Flow 20 (T)	2. Number of Heat Zones (0, 4)	3. Heat Controls Supply Voltage (0, 2, 3, 4)	4. Pump Ratio (0)	5. Heated Platen (F, S)	6. Controls (0, B, S)	Part No.
T	4	230 (2)	15:1 (0)	Finned (F)	Standard (B)	T420FB
T	4	230 (2)	15:1 (0)	Smooth (S)	Standard (B)	T420SB
T	4	380 (3)	15:1 (0)	Finned (F)	Standard (B)	T430FB
T	4	380 (3)	15:1 (0)	Smooth (S)	Standard (B)	T430SB
T	4	480 (4)	15:1 (0)	Finned (F)	Standard (B)	T440FB
T	4	480 (4)	15:1 (0)	Smooth (S)	Standard (B)	T440SB
T	4	230 (2)	15:1 (0)	Finned (F)	Secondary (S)	T420FS
T	4	230 (2)	15:1 (0)	Smooth (S)	Secondary (S)	T420SS
T	4	380 (3)	15:1 (0)	Finned (F)	Secondary (S)	T430FS
T	4	380 (3)	15:1 (0)	Smooth (S)	Secondary (S)	T430SS
T	4	480 (4)	15:1 (0)	Finned (F)	Secondary (S)	T440FS
T	4	480 (4)	15:1 (0)	Smooth (S)	Secondary (S)	T440SS
T	0	0	15:1 (0)	Finned (F)	No Controls (0)	T000F0
T	0	0	15:1 (0)	Smooth (S)	No Controls (0)	T000S0

## Component Identification

Before installing the system you should be familiar with all the Therm-O-Flow system components. See FIG. 1. Contact your Graco distributor for help in designing a system to suit your particular needs.

The air-powered ram extruder forces high viscosity fluids into the intake valve of the fluid pump. Wiper rings and other accessory equipment for use with this ram are listed in **Spare Parts and Kits** on page 48.

### Air Line Components

The following components are included with the unit. See FIG. 1.

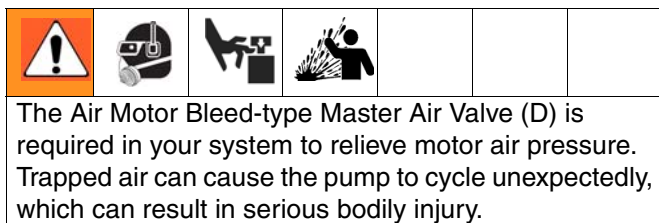

- System Master Air Valve (A) is used to shut off the air supply to the entire system.
- Air Line Filter (B) removes dirt and moisture from the compressed air supply.
- Air Motor Enable Solenoid/Depressurization Valve (V) opens to allow air to the air regulator (C) and exhausts air from the air motor at shutoff. The built-in control delays start-up to allow material to heat thoroughly.
- The Air Motor Remote Piloted Air Regulator (X) regulates air pressure to the air motor.
- Air Motor Bleed-type Master Air Valve (D) shuts off the air supply to the air motor and bleeds trapped air from the air motor.

### Pneumatic Control Panel

The pneumatic control panel includes the following. See FIG. 1.

- Platen Blow-off Valve (S) directs air to the underside of the platen when depressed.
- Blow-off Air Regulator (T) controls the air pressure to the platen blow-off valve.
- Air Motor Air Regulator (C) controls the pump outlet pressure by adjusting the air pressure to the air motor.
- Ram Up/Down Lever (R) changes the direction of the ram.
- Ram Air Regulators (N, P) control the air pressure to the ram. There are separate air regulators to control the ram pressure in the up and down directions.

### EasyKey Display and Keypad

EasyKey is a simple user interface consisting of an LCD display and keypad (L) which controls Therm-O-Flow 20 operations.

### Air and Fluid Hoses



The Therm-O-Flow 20 requires Graco single-circuit material hoses rated at a maximum of 1250 watts.

When installing a system make sure that all air and fluid hoses are properly sized and pressure rated for the system.

### Fluid Line Accessories (Typical)

A pressure compensator valve controls fluid pressure to the gun/valve, and dampens pressure surges. Install a pressure compensator valve in the fluid line, using adapters as necessary

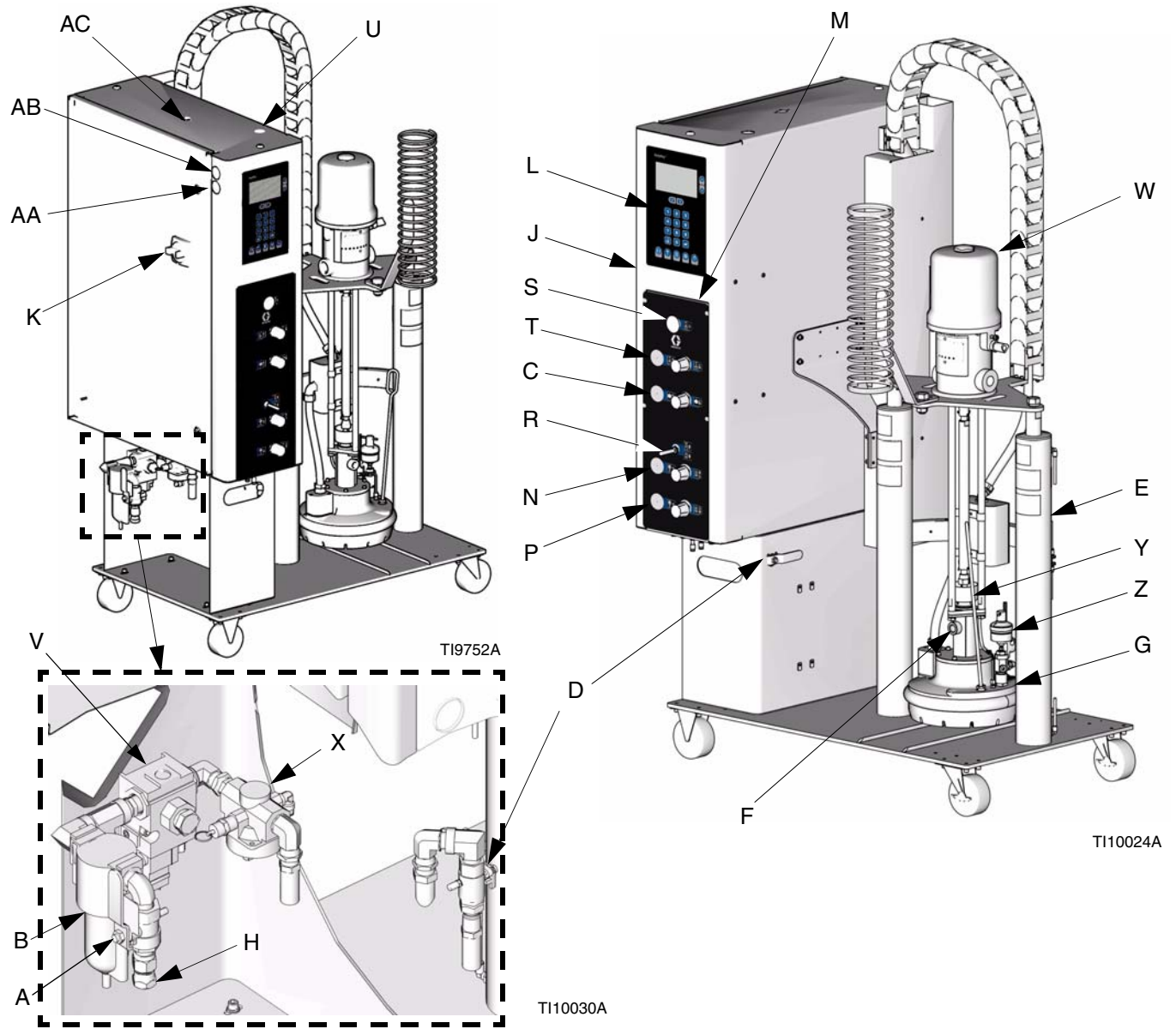

**FIG. 1: Component Identification**

- |   |                                                |    |                                                  |
|---|------------------------------------------------|----|--------------------------------------------------|
| A | System Bleed-type Master Air Valve             | N  | Ram Up Air Regulator and Gauge                   |
| B | Air Line Filter                                | P  | Ram Down Air Regulator and Gauge                 |
| C | Air Motor Air Regulator (bleed-type) and Gauge | R  | Ram Up/Down Lever                                |
| D | Air Motor Bleed-type Master Air Valve          | S  | Platen Blow-off Pushbutton                       |
| E | Ram                                            | T  | Blow-Off Air Regulator and Gauge                 |
| F | Pump                                           | U  | Electrical Power Input                           |
| G | Platen                                         | V  | Air Motor Enable Solenoid/Depressurization Valve |
| H | Air Inlet (1/2" npt)                           | W  | Air Motor                                        |
| J | Electrical Control Panel                       | X  | Air Motor Remote Piloted Air Regulator           |
| K | Main Power Disconnect Switch                   | Y  | Platen Bleed Stick                               |
| L | EasyKey Display and Keypad                     | Z  | Pail Blow Off Valve                              |
| M | Pneumatic Control Panel                        | AA | Maintenance Call                                 |
|   |                                                | AB | Ethernet Connection                              |
|   |                                                | AC | Light Tower Connection                           |

## Power Requirements

See Table 1, and the **Technical Data** on page 69.

**Table 1: Power Requirements**

AC Panel Voltage	HZ	Phase	Full Load Amps
240	50/60	3	30
380	50/60	3	14
480	50/60	3	15.2

## Heat Control Zone Selection

The Therm-O-Flow 20 has 4 heat zones (see FIG. 2).

- Zone 1 is always used for the heated pail platen.
- Zones 2 and 3 are available as paired zones through 16-pin connectors.
- Zone 4 is not paired, available through a 16-pin connector.

The heated hoses have a 16-pin connector on the inlet end cable, and an 8-pin connector on the outlet end cable. All heated valves, manifolds, and heaters are equipped with an 8-pin matching connector. Accessory cables are available for other possible combinations.

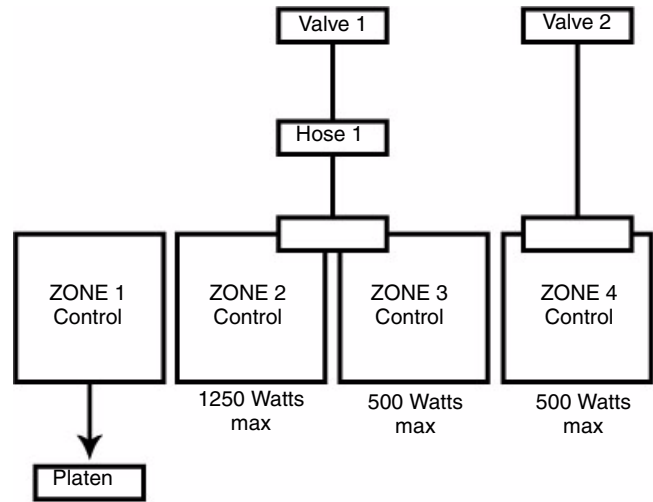

T110093A

**FIG. 2: Heat Control Zone Selection**



# Installation

The installation procedure includes:

- unpacking the ram
- locating and installing the ram
- mechanical setup
- electrically connecting hoses to the electrical control panel
- grounding the system
- connecting the electrical control panel to a power source
- connecting to an air source
- setting controls on the electrical control panel

## Unpacking

1. Inspect the shipping box carefully for damage. Contact the carrier promptly if there is damage.
2. Open the box and inspect the contents carefully. There should not be any loose or damaged parts in the box.
3. Compare the packing slip against all items in the box. Report any shortages or other inspection problems immediately.

## Location Requirements

Refer to the **Dimensions** drawing on page 68 for ram mounting and clearance dimensions.

1. Make sure there is sufficient overhead clearance for the pump and ram when the ram is in the fully raised position (approximately 82 in. [209 cm]).
2. If you are installing a vent hood, make sure there is sufficient horizontal clearance for it. Locate the ram near a connection to the factory ventilation system.
3. Make sure the air regulators for the pump and ram are fully accessible, with room to stand directly in front of the pneumatic control panel and the electrical control panel.
4. Make sure there is easy access to an appropriate electrical power source. The National Electrical Code requires 3 ft (0.9 m) of open space in front of the electrical panel.

## Locate and Install the Ram

1. Apply 50 psi download pressure to ram.

### CAUTION

Always lift system at proper lift locations (see FIG. 3). Do **not** lift in any other way.

2. Attach a lifting sling at the proper lift spots (see FIG. 3). Lift off the pallet using a crane or a forklift.

 To mount the ram directly to the floor, remove the four wheels.

3. Position the ram in the desired location.
4. Lock the wheels, or bolt the ram to the floor. To bolt the ram to the floor, level the base using metal shims. Bolt the ram to the floor, using anchors that are long enough to prevent the unit from tipping.

Lift Locations (if air is supplied to the system and ram lever is set to down)

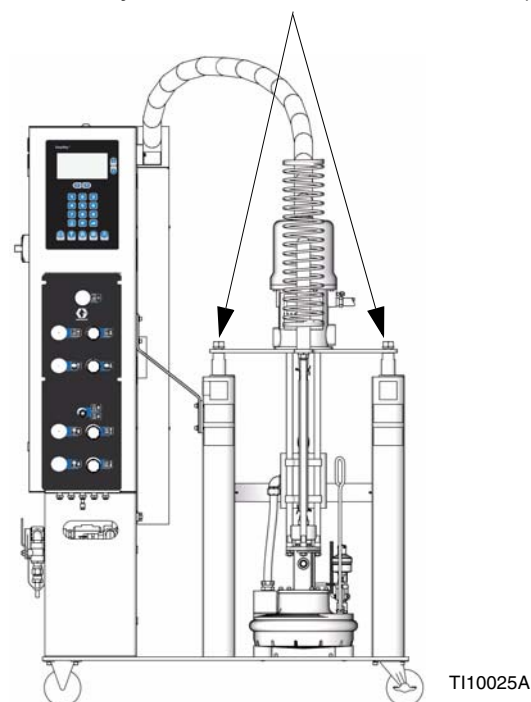

**FIG. 3: Lift Locations**

## Mechanical Setup

1. Check, and if necessary, tighten the heated hose connection at the pump outlet.
2. Wrap exposed fittings on the pump outlet with Nomex insulation and secure insulation using fiberglass tape.
3. Fill displacement pump wet cup 2/3 full with Graco Throat Seal Liquid (TSL).
4. Turn all air regulators to their full counterclockwise position.
5. Connect a 1/2 in. (13 mm) air line from an air source to the system air inlet, see FIG. 1, page 7, letter (H) capable of delivering a minimum of 15 cfm (0.4 m<sup>3</sup>/m) at 100 psi (0.7 MPa, 7.0 bar). **Do not use quick disconnects.**

## Electrically Connect Hoses

 The Therm-O-Flow 20 requires Graco single-circuit material hoses rated at a maximum of 1250 watts.

1. Securely tighten the 16-pin electrical connectors on long heated hose leads into 16-socket receptacles located on the back of the electrical control panel. See FIG. 4.
2. Securely tighten the 8-socket electrical connectors on short heated hose leads into 8-pin receptacle located on the dispense valves.

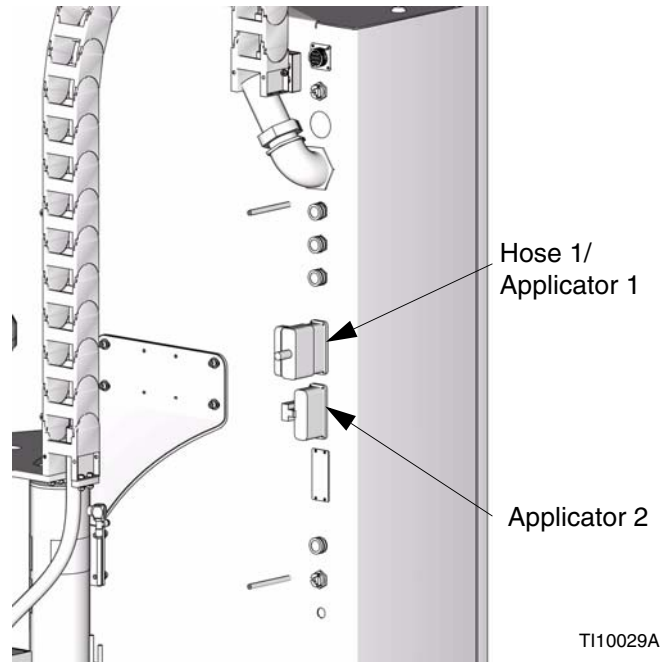

FIG. 4: Rear View of Electrical Control Box

## Connect the Electrical Control Panel to a Power Source

The electrical control panel (FIG. 5) comes already attached and wired to the ram, however before the supply unit becomes functional, you must connect the electrical control panel to a power source.



### CAUTION

If power and grounding connections are not done properly, the equipment will be damaged and the warranty will be voided. Before running power to the unit, make sure the plant electrical service meets the machine's electrical requirements. Check the label on the control box for the required voltage and amperage.

Have a trained electrician connect the electrical control panel (Fig. 5) to a grounded electrical source that has the required service ratings. See **Power Requirements** on page 8 and **Electrical Schematics** on page 49.

 For information about specific terminal locations and connections, see **Electrical Schematics** on page 49.

To connect the control panel to the electrical source:

1. Open electrical enclosure door and locate the main disconnect (K).
2. Have a qualified electrician connect your plant power to the electrical control panel disconnect switch according to local codes. A 1-3/8 in. (35 mm) diameter opening is provided on top of the panel above the connections. This opening is suitable for a 1 in. npt conduit or strain relief fitting.
3. Thread the wire from the power source into the control panel housing, and then connect the power source wires to the appropriate terminals on the main disconnect (K).

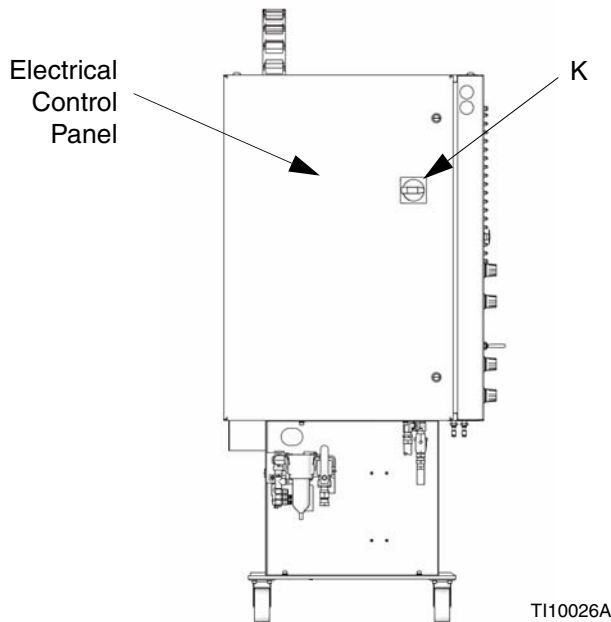

TI10026A

**FIG. 5: Electrical Control Panel**

## Grounding

Ground the supply unit as instructed here and in the individual component manuals.







The power source conduit is not an adequate ground for the system. The unit must be bonded to either the building ground or a true earth ground. To reduce the risk of static sparking, ground the pump, the object being dispensed to, and all other spraying/dispensing equipment used or located in the spraying/dispensing area. Check your local electrical code for detailed grounding instructions for your area and type of equipment.

- *Air and fluid hoses:* Use only electrically conductive hoses.
- *Dispensing/Spray Gun:* Follow the dispensing/spray gun grounding instructions.
- *Object material is applied to:* Ground according to your local code.
- *Material pails:* Ground according to your local code. Use only metal pails placed on a grounded surface. Do not place the pail on a nonconductive surface, such as paper or cardboard, which interrupts the grounding continuity.
- *Maintain grounding continuity when flushing or relieving pressure:* Follow the instructions in your separate gun manual for safely grounding your gun while flushing.

## Check Resistance



### Check the Resistance Between the Supply Unit and the True Earth Ground

						
The resistance between the supply unit components and true earth ground must be less than 0.25 ohms.						

Have a qualified electrician check the resistance between each supply unit component and the true earth ground. The resistance must be less than 0.25 ohms. If the resistance is greater than 0.25 ohms a different ground site may be required. Do not operate the system until the problem is corrected.

 Use a meter that is capable of measuring resistance at this level.

### Sensor Resistance Checks

						
Conduct these electrical checks with the main disconnect OFF.						

The package includes a heat sensor and controller for each of the four heated zones. To check sensor resistance:

1. Make sure the power is off and that the disconnect switch is in the OFF position.
2. Make electrical resistance checks for the components.



3. Replace any parts whose resistance readings do not comply with the ranges listed in Table 2.

 Check resistance at ambient room temperature (63°– 77°F [17°– 25°C]).

**Table 2: RTD Sensors**

Zone	Component	Terminals	Range (ohms)
1	Platen	2011 & 2012	108 +/- 2%
2	Dispense Hose 1	2051 & 2061	108 +/- 2%
3	Dispense Gun 1	2081 & 2091	108 +/- 2%
4	Dispense Gun 2	2111 & 2121	108 +/- 2%

### Heater Resistance Checks

						
Conduct these electrical checks with the main power disconnect OFF.						

To check heater resistance:

1. Make sure the power is off and that the disconnect switch is in the OFF position.
2. Make electrical resistance checks for the components. See **Electrical Schematics** on page 49 for wiring diagram information.
3. Replace any parts whose resistance readings do not comply with the ranges listed in Table 3 on page 13.

 Check resistance at ambient room temperature (63°– 77°F) (17°– 25°C).

**Table 3: Resistance Chart of All Heaters**

Zone	Component	Between Terminals	Unit Voltage	Resistance Values (ohms)
1	Platen	E to D, F to A (without jumpers)	240V	28.8 +3/-4
		3L1 to 3L2 (with jumpers)	240V	14.4 +1.5/-2
		E to F, D to A (with jumpers)	380V/480V	28.8 +3/-4
		3L1 to 3L2 (with jumpers)	380V/480V	57.6 +6/-8
		Any to Ground		100,000 minimum

## Overview of the Temperature Controller Settings

Temperature controls are set in the zone configuration setup screens. See **System Run Screen** on page 16 for information about setting temperature controls.

P, I, and D settings are preset for device types and will not need to be changed. Refer to the **Zone Setup Screens** on page 17 for a list of device types and how to set them for each zone.

## Purging the System





Purging the system before the initial use can prevent material contamination, which may cause the material to fail or perform poorly.

<b>CAUTION</b>
Purge the system before performing the initial <b>material loading procedure</b> . The system was factory- tested using a light soluble oil, a soybean oil, or some other oil as tagged. Flush the system to avoid contaminating the material that has been designated for initial material loading.

To purge the system perform the following procedure:

1. Select the material for the initial material load.
2. Verify whether the factory-test oil and the initial material load are compatible:

- a. If the two substances are compatible omit the remaining steps in this procedure and refer to the start up and operation instructions.
- b. If the two substances are incompatible perform the remaining steps in this procedure to flush the system at ambient temperature.

						
Use fluids that are chemically compatible with the equipment wetted parts. See the <b>Technical Data</b> sections of all the equipment manuals.						

3. Select a pail of material that can eliminate the factory-test oil from the system. If necessary, check with Graco or the material supplier for a recommended solvent.
4. Before purging be sure the entire system and waste pail are properly grounded. Refer to **Grounding** on page 11.
5. Turn all heat zones to 70°F (21.1°C). This allows air to the air motor, with no alarms, in a cold state. Heat soak must = 0 or you will need to wait for the preset time to elapse (default is 45 minutes).

 Remove any dispense valve orifices before purging. Reinstall after purging has been completed.

6. Purge the material through the system for approximately 1 to 2 minutes.
7. Remove the pail if purge material was used.

# Operator Controls

## Main Power Disconnect

Turns system power on or off. Includes system circuit breaker. See FIG. 6.

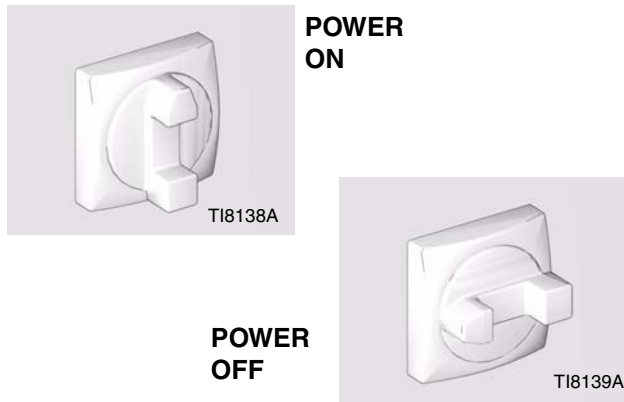

**FIG. 6: Main Power Disconnect**

In a Tandem System, the secondary unloader provides 24VDC power to the EasyKey display. This allows the primary unloader to be powered down for maintenance without interrupting production. All accessories (light tower, swirl, etc.) and the display board on the primary system will have power when the secondary unloader is powered on and the primary unloader is powered off.

## EasyKey Display and Keypad

The EasyKey Display is a simple user interface consisting of an LCD display (A) and keypad (B). See FIG. 7.

Use to input numerical data, enter Setup screens, scroll through screens, and select setup values. See page 16 for additional keypad/screen navigation information. The EasyKey includes numbered keys to enter values in setup and the function keys listed in Table 4.

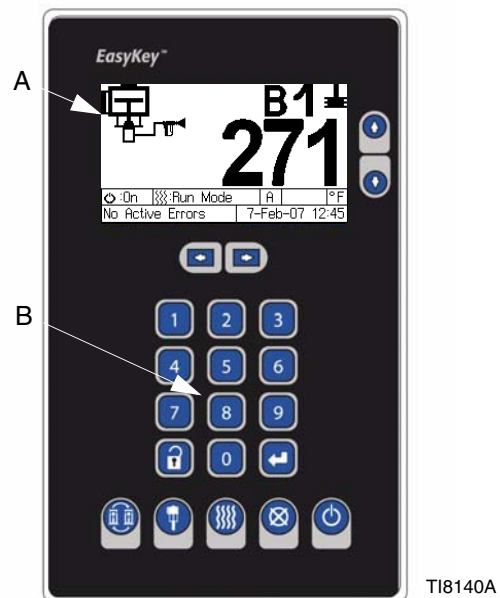











**FIG. 7: EasyKey Display and Keypad**

**Table 4: Key Descriptions**

Key	Function
	<i>Setup:</i> press to enter or exit Setup mode.
	<i>Enter:</i> if cursor is in drop-down list box, press Enter key to view drop-down list. Press Enter to save a value either keyed in from the numerical keypad or selected from a drop-down list.
	<i>Up Arrow:</i> move to previous field or drop-down list item.
	<i>Down Arrow:</i> move to next field, or drop-down list item.

*Continued on page 15.*

Table 4: Key Descriptions

	<i>Left Arrow: move to previous screen.</i>
	<i>Right Arrow: move to next screen.</i>
	<i>System On/Off: on starts system. Activates , , , and  keys.</i>
	<i>Heat State Toggle: starts heaters in all zones where they are enabled. Cycles through heat states (Heat Off, Heat On/Heat Soak/Run, Setback).</i>
	<i>Clear: clears alarms and warnings.</i>
	<i>Pump Ready: allows pump to cycle after a DRUM EMPTY condition is removed.</i>
	<i>Pump Crossover: transitions the active system to the inactive unloader.</i>

## LCD Display

The two run screens show graphical and text information related to setup and spray operations.

A screen saver option is available in the Advanced Setup screen 4 (see Table 7, page 21).

- A **Animation:** when there is flow the air motor piston and pump displacement rod move and the gun appears to spray.
- B not used.
- C not used.
- D **Zone Number and Icon:** shows which zone data is currently being displayed. Icon indicates component for that zone.



E **Temperature Readout:** shows current temperature of each zone, in temperature units selected in Table 7, see page 21.

F **Status Bar:** shows current operation mode or alarm.

G **Current Date and Time**

H **Security Level:** a padlock appears on the screen if a password is required to enter Setup mode. If the password was set to 0, no padlock appears and setup can be entered without a password.

You must be in system off mode to enter setup

## Alarm

Alerts the user to an alarm condition. Press  to clear the alarm.

# EasyKey Display Screens

## Power Up Screens

When the EasyKey power switch is turned on the Graco logo screen and the phrase “Establishing Communication” displays for several seconds before the system run screen appears.



If the EasyKey cannot communicate with any board during the power on phase, the phrase “Communication Error” displays on the Graco Logo screen. Once communications are established the System Run Screen appears. See FIG. 9.

Run screens and setup screens are the two main screen types that provide information and system control.

## Run Screens

### System Run Screen

The System Run screen displays and cycles through the operating status of each enabled zone in sequence. See FIG. 8.

From the System Run screen, press the Left Arrow  or Right Arrow  key to move to the Zone Run screens.

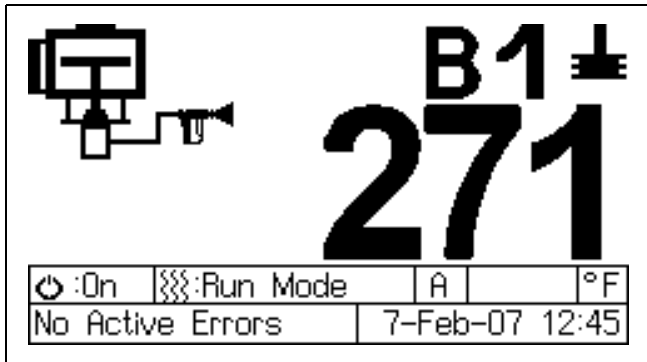







FIG. 8: System Run Screen

### Zone Run Screen

The Zone Run screen displays a summary of all 4 zones in the system. See FIG. 9.

Tandem or expansion systems contain two 4 zone run screens (A and B). See FIG. 9 and FIG. 10.

From the Zone Run screen, press the Left Arrow  or Right Arrow  key to move to the System Run screen.

 Temperature setpoints are adjustable on this screen if Setpoint Adjust is turned on. See **Advanced Screens**, page 20. Setpoints will be highlighted in a box. Use the Up Arrow  or Down Arrow  keys to move among the setpoints.

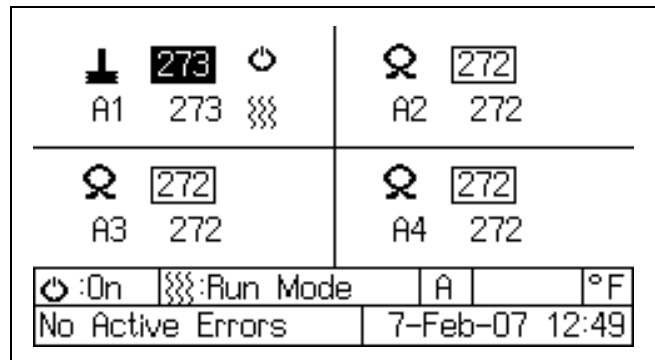

FIG. 9: Zone A Run Screen

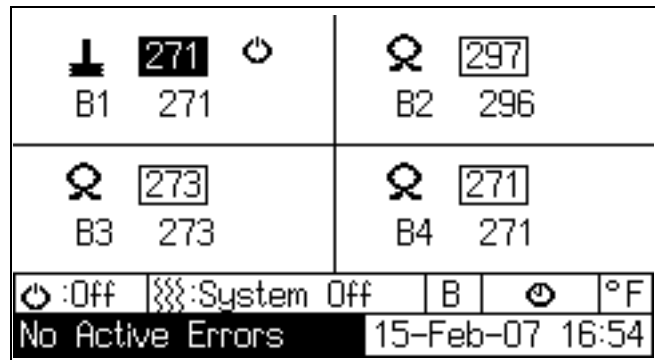

FIG. 10: Zone B Run Screen



## Setup Mode

### Entering Setup

Press  to enter or exit Setup. You must be in system off state to enter setup.

### Password Screen

If a password was enabled you must enter the password before entering Setup mode. See Table 7, page 21. Entering the wrong password returns you to the Run screens.

 If a password is enabled, "Setup Locked" displays momentarily after exiting Setup mode and returning to the Run screens.

### Setup Screen Menu

The Setup screens contain tabs across the bottom of the screen for the Zone, Timer, Report, and Advanced screens. The current screen is highlighted. See FIG. 11 and FIG. 12.

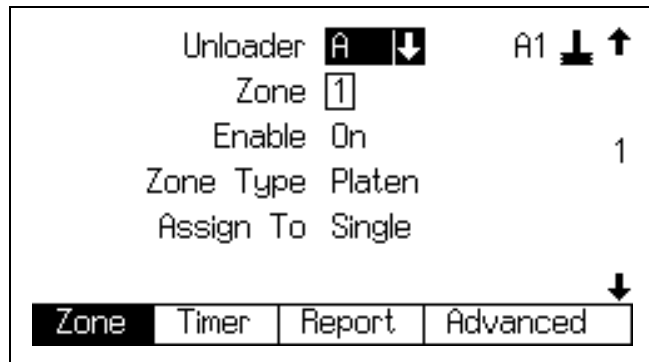



FIG. 11: Setup Screen 1

## Zone Setup Screens

Zone Setup has 2 screens. The screen number appears on the right side of the screen. See FIG. 11 and FIG. 12. See Table 5 on page 18 for settings.

 Press the Enter  key to show drop-down lists and to enter your selection.

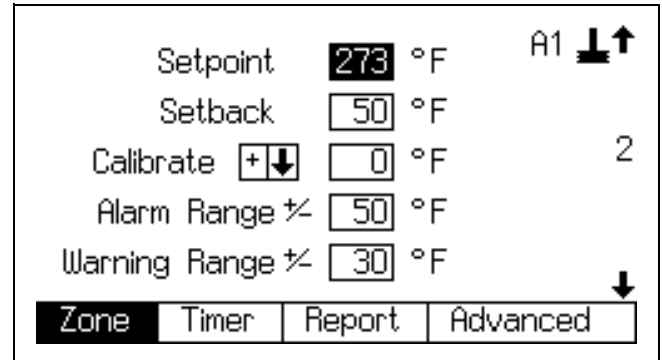

FIG. 12: Setup Screen 2

**Table 5: Zone Setup Screens**

Screen	Setting	Selection	Description
1 (See FIG. 11)	Unloader		In single system always A. In tandem or expansion system it is selectable between A and B.
	Zone	Numeric	Enter desired zone (1-4). Zone 1 (platen) is fixed. All other zones are selectable (hose, gun, regulator, manifold, meter).
	Enable	On/Off	Select On or Off to turn zone heat on or off.
	Zone Type	Hose/ Gun/ Regulator/ Manifold/ Meter	Select desired component for heat zones 2 through 4. Zone 1 (platen) is fixed. Zone icons on Run screens will match selections.
	Assign to		Tandem system only. Determines unloader zone is assigned to for heat control.
2 (See FIG. 12)	Setpoint	Numeric	Enter the temperature to which material needs to be heated. Consult material supplier for recommended material application temperatures.
	Setback	Numeric	Enter desired temperature to maintain during downtime, so material will not cool completely.
	Calibrate	+/- Numeric	Select +/-, then enter desired calibration temperature. Use if Zone Temp reading does not match ambient temperature of location.
	Alarm Range +/-	Numeric	Enter temperature range from setpoint at which an alarm condition will occur.
	Warning Range +/-	Numeric	Enter temperature range from setpoint at which a warning condition will occur.

### Timer Screen

Timer settings are explained in Table 6. See also FIG. 13 and FIG. 14.

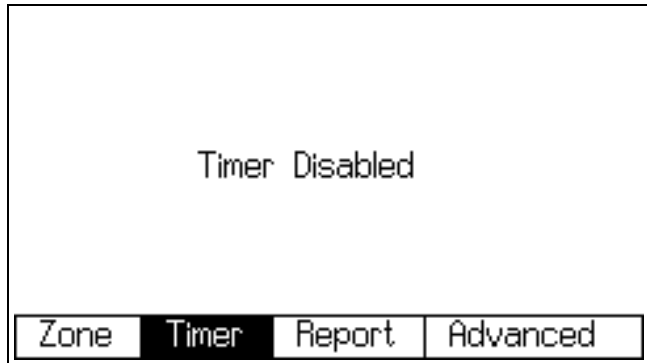

FIG. 13: Timer Screen Disabled

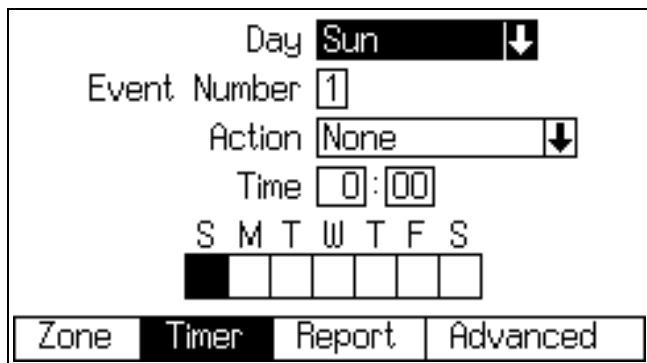





FIG. 14: Timer Screen, with individual day and setback action selected

### Report Screen

The Report screen shows the most recent 18 alarms, with the date and time. Use the Up Arrow  or Down Arrow  keys to see all the alarms. See FIG. 15.

There are no selectable settings on the Report screen.

Date	Time	Alarm
01 14-Feb	15:28	A Comm. Error 
02 14-Feb	12:52	B Comm. Error
03 14-Feb	12:52	A Comm. Error
04 14-Feb	12:50	A Comm. Error
05 07-Feb	12:55	Setup Changed
06 07-Feb	12:54	A1 High Temperature 

Below the table is a menu bar with "Zone", "Timer", "Report", and "Advanced" buttons. The "Report" button is highlighted with a black background.

FIG. 15: Report Screen

Table 6: Timer Setup Screen

Setting	Selection	Description
Day	Individual/ M-F/ S-S/ All	Select desired day(s). Selected days will be highlighted in calendar on screen.
Event Number	1-5	Select desired event number (maximum of 5 events per day).
Action	None	No timer value entered for selected event.
	Off	Turns off timer for selected event.
	On	Turns on timer for selected event.
	Setback	Turns on setback function for selected event.
	Clear All	Clears all timer events for selected day.
Time	Numeric	Enter hours (0-23) and minutes (0-59).

## Advanced Screens

Advanced setup has 3 screens. The screen number appears on the right side of the screen. See FIG. 16 through FIG. 18, and Table 7 on page 21.

 Press the Enter  key to show drop-down lists and to enter your selection.

Language	English	↓	↑				
Number Zones	4+4S	↓					
Change Setpoint	Yes	↓	1				
Temperature Units	° F	↓					
Heat Soak	0	minutes	↓				
<table border="1"> <tr> <td>Zone</td> <td>Timer</td> <td>Report</td> <td>Advanced</td> </tr> </table>				Zone	Timer	Report	Advanced
Zone	Timer	Report	Advanced				

FIG. 16: Advanced Screen 1

7-Day Timer	Off	↓	↑				
External Pump Enable	Off	↓					
			2				
			↓				
<table border="1"> <tr> <td>Zone</td> <td>Timer</td> <td>Report</td> <td>Advanced</td> </tr> </table>				Zone	Timer	Report	Advanced
Zone	Timer	Report	Advanced				

FIG. 17: Advanced Screen 2

Month	Feb	2	↑				
Day		7					
Year		2007	3				
Time		12:53					
Enter Password		0000					
Screen Saver Time		0	minutes				
			↓				
<table border="1"> <tr> <td>Zone</td> <td>Timer</td> <td>Report</td> <td>Advanced</td> </tr> </table>				Zone	Timer	Report	Advanced
Zone	Timer	Report	Advanced				

FIG. 18: Advanced Screen 3

Table 7: Advanced Setup Screens

Screen	Setting	Selection	Description	Default
1 (See FIG. 16)	Language	English, Spanish, German, French, Japanese, Chinese, custom	Language displayed. The language is set at factory.	English
	Number Zones	4 / 4+4 / 4+4S	The number of zones in system is set at the factory.	4
	Change Setpoint	Yes/No	Select Yes or No to allow operator to change setpoints from the Zone Run screen.	Yes
	Temperature Units	°F/°C	Select desired temperature units.	F
	Heat Soak	Numeric	Enter time (in minutes) to delay air motor start after all zones reach temperature setpoints.	45
2 (See FIG. 17)	7-Day Timer	On/Off	(Enable / Disable 7 day timer).	Off
	External Pump Enable	On/Off	Allows external device to control pump.	Off
3 (See FIG. 18)	Month	Numeric	Select current month (1-12).	1
	Day	Numeric	Select current day (1-31).	1
	Year	Numeric	Select current year (4 digits).	0000
	Time	Numeric	Enter hours (0-23) and minutes (0-59).	0 0
	Password	Numeric	Is only used to enter Setup mode. Default is 0, which means no password is required to enter setup. To set a password, enter a number (1–9999).	0000
	Screen Saver Time	Numeric	Enter minutes (1-99) for screen to be inactive before screen saver turns on (screen dims). Press any key to restore. Default is 0 (screen saver off).	0

# Setup

## Purge Before Using Equipment

The equipment was tested with lightweight oil, which is left in the fluid passages to protect parts. To avoid contaminating your fluid with oil, purge the equipment with a compatible material before using the equipment. See **Purging the System**, page 13.

## Set Values on EasyKey

Set desired values on EasyKey setup menus. See **Setup Mode**, page 17.

## Material Loading

### CAUTION

Do not use a pail of material that has been dented or otherwise damaged; damage to the platen wiper can result.

Before loading material, make sure there is a minimum overhead clearance of 82 in. (209 cm) and all air regulators are backed off to their full counter-clockwise position.

1. Open the system bleed-type master air valve (A).

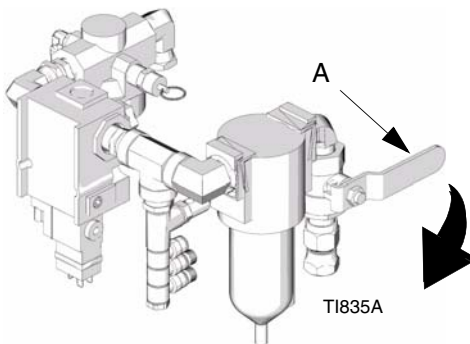

2. Place the ram UP/DOWN lever in the UP position.



3. Slowly turn the ram UP regulator (N) clockwise until the ram begins to rise. See FIG. 19.
4. When the ram is fully raised, install the pail.

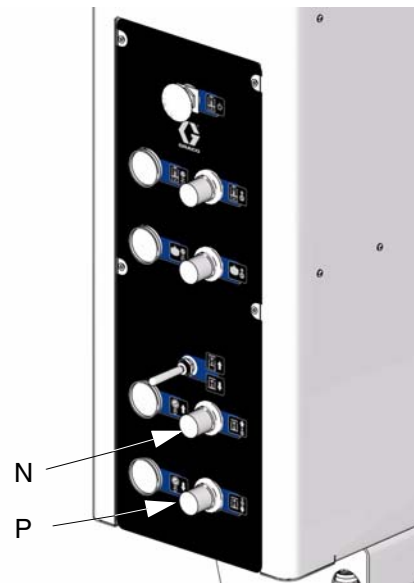

**FIG. 19: Pneumatic Control Panel**

5. Apply a thin coating of high temp grease lubricant (part no. 115982) to the platen seals (PS). See FIG. 20.
6. Add TSL fluid to wet cup. Fill approximately 2/3 full.
7. Open pail, remove any packing material, and inspect material for any contamination.
8. Slide the pail into position. Be sure it is pushed all the way against the stops at the back of the ram baseplate.
9. Remove the platen bleed stick (Y). See FIG. 20.
10. Place the ram UP/DOWN lever in the DOWN position.

**CAUTION**

Lowering the ram without a pail in place can damage the pail centering guides (if equipped).

- See FIG. 19. Slowly turn the ram DOWN regulator (P) clockwise to approximately 5-10 psi (34-69 kPa, 0.3-0.7 bar). The platen will begin to lower into the pail.



- After the platen seal (PS) enters the material pail, adjust the ram DOWN air regulator (P) to 30-50 psi (207-345 kPa, 2.1-3.4 bar). See FIG. 19 and FIG. 20.
- When the ram stops, reinsert the platen bleed stick (Y) and hand tighten. See FIG. 20.

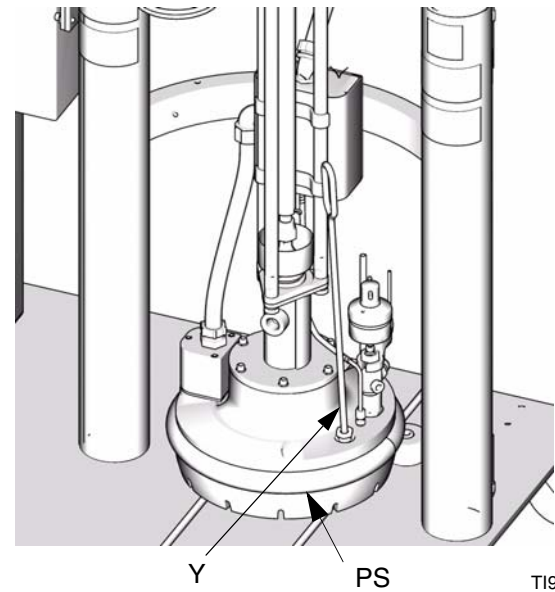

**FIG. 20: Platen**

## System Heat Up



Never pressurize a hot melt system before turning on the heat. The air will be locked from the air motor until all temperature zones are within a preset window of the temperature set points.



### CAUTION

The dispense valve must be kept open over a waste container while the system is heating up and also when cooling down. This will prevent a pressure build-up caused by fluids or gasses expanding from the heat.

1. Turn the main disconnect on the electrical control panel door to the ON position.

POWER  
ON





2. Press . Display status bar reads **System On and Heat Off**.
3. Press . The zones begin to heat (provided they are enabled). Display status bar reads **Heat On**. When temperature reaches setpoint, display status bar reads either **Run Mode** or **Heat Soak**, depending on user setting.

 The air will be locked from the air motor until all temperature zones are within a preset window of the temperature set points, allowing the system to heat fully and complete the material heat soak period.

## Prime System



 In a Tandem system, after a pail change has occurred on the inactive unloader, pressing the

Pump Ready  key will allow five minutes of air to the air motor to allow for the pump to be primed. The inactive unloader must be within its warning deviation setpoints and in the Ready or Heat On state. If the five minute timer runs out before the inactive unloader is primed, pressing the Pump Ready key again will repeat the air to the air motor.

1. Make sure the system has completed the approximately 45 minute heat soak cycle and is up to temperature.
2. Close the air motor valve (D).

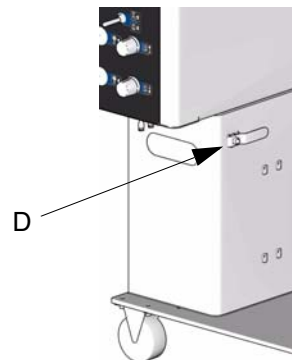

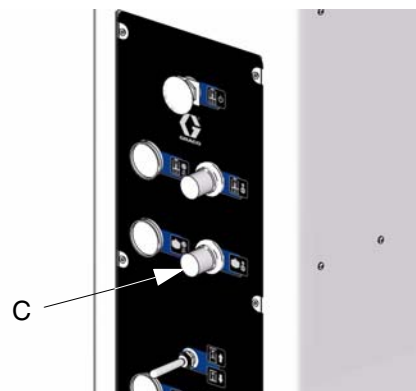

TI10094A

3. Adjust the air motor air regulator (C) to approximately 20 psi (138 kPa, 1.38 bar) on pneumatic panel.



TI8142A



4. If a new pail was installed and:
  - If the unit is equipped with proximity sensors, press the Pump Ready key .
  - If the unit is not equipped with proximity sensors, press the Clear key  if a motor error is present, then press the Pump Ready key .
5. If using a manual gun, lock the dispense valve trigger open by pulling and securing the trigger using the trigger retainer (TR).

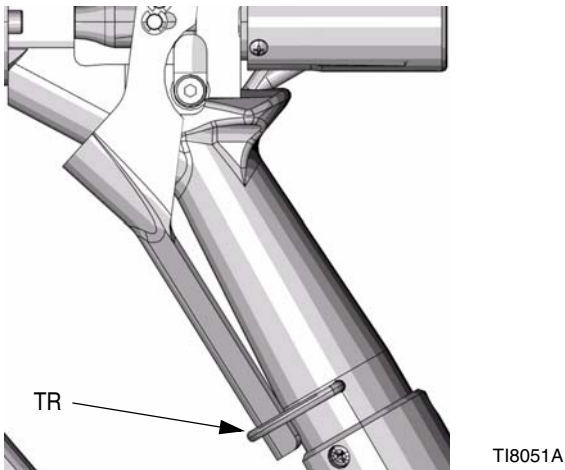

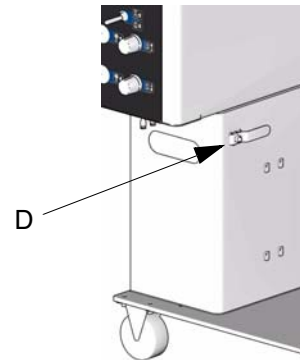

6. Place the dispense valve over a waste container.

7. With waste container in place, slowly open the air motor valve (D).



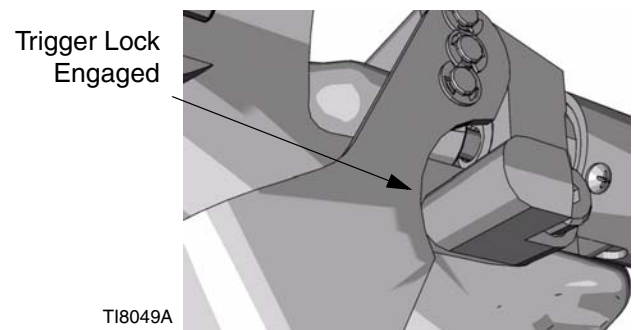



8. If the pump does not cycle, adjust the air motor air regulator (C) up by 5 psi (34 kPa, 0.3 bar). Never adjust the regulator by more than 5 psi (34 kPa, 0.3 bar) increments.
9. Prime the system until a smooth flow of material dispenses from the dispense valve.
10. Close the pump bleed-type master air valve (D) and release trigger retainer.
11. Engage trigger lock.



 The system is now ready to operate.

# Operation

## Pressure Relief Procedure

						
<p>Follow <b>Pressure Relief Procedure</b> when you stop spraying and before cleaning, checking, servicing, or transporting equipment.</p>						

This procedure describes how to relieve pressure for the supply unit. Use this procedure whenever you shut off the unit and before checking or adjusting any part of the system.

1. Engage trigger lock.

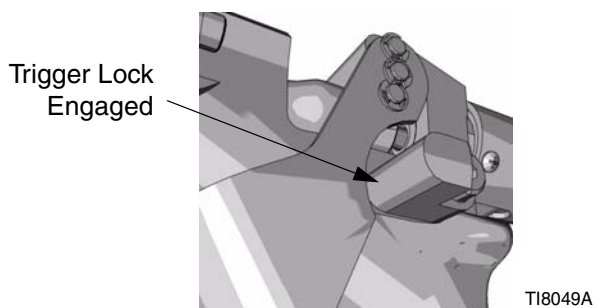

2. Close the system bleed-type master air valve (A).

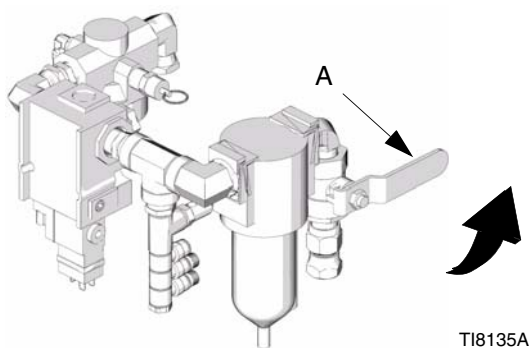

3. Disengage trigger lock.

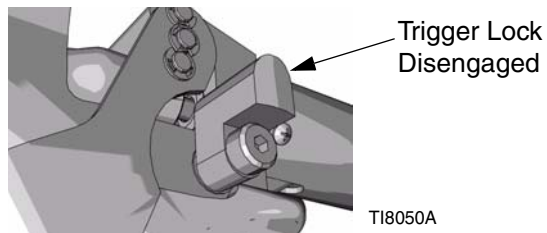

4. Hold a metal part of the gun firmly to a grounded metal pail. Trigger the gun to relieve pressure.
5. Engage trigger lock.

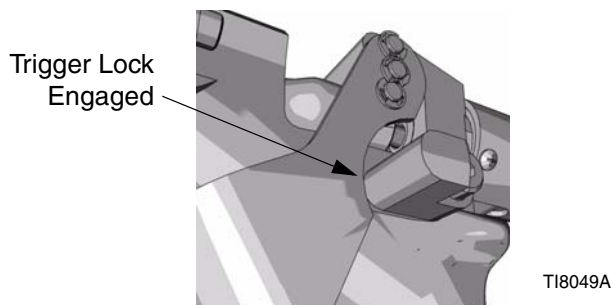

6. Open all fluid drain valves in the system, having a waste container ready to catch drainage. Leave drain valve(s) open until you are ready to spray again.



If you suspect the spray tip or hose is clogged or that pressure has not been fully relieved after following the steps above, **VERY SLOWLY** loosen hose end coupling to relieve pressure gradually, then loosen completely. Clear hose or tip obstruction.

7. To relieve pressure in the ram, see page 27.

## Trigger Lock

Always engage the trigger lock when you stop spraying to prevent the gun from being triggered accidentally by hand or if dropped or bumped.

# Ram Pressure Relief Procedure

						
<p>Follow <b>Pressure Relief Procedure</b> when you stop spraying and before cleaning, checking, servicing, or transporting equipment.</p>						

To relieve air pressure in the ram:

1. Relieve the supply unit pressure, see page 26.
2. Place the ram UP/DOWN lever in the DOWN position. Move the ram to the DOWN position.

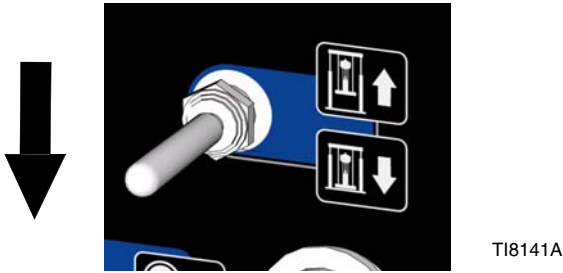

3. When the ram reaches the full down position, place the ram UP/DOWN lever in the center position (off).
4. Close the system bleed-type master air valve (A).

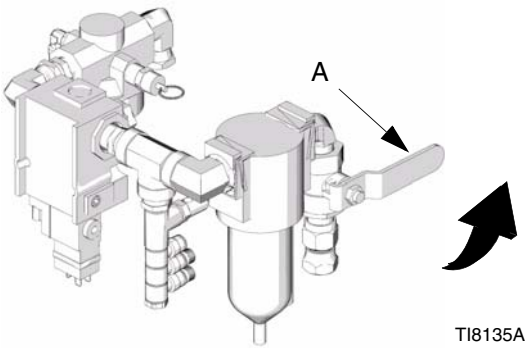

5. Exhaust air from both sides of the ram:
  - a. Move the ram UP/DOWN lever to the DOWN position until all air is exhausted from one side of the ram.



- b. Move the ram UP/DOWN lever to the UP position until all air is exhausted from the other side of the ram.

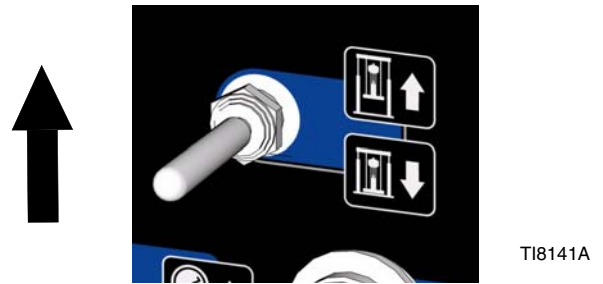

## Pail Changing

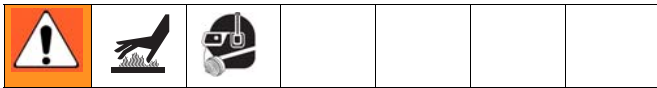

Follow the procedure below to change the pail on a fully heated machine.

### CAUTION

**Be sure to reload the empty supply unit with a full pail of material immediately.** Do not raise the ram and remove the platen from the empty pail until you are ready to immediately install a new pail.

**Do not raise the ram and remove the platen from the empty pail unless the supply unit is at full operating temperature.** Pail changes can only be performed when the system is heated.

**Do not use a pail of material that has been dented or otherwise damaged;** damage to the platen wiper can result.

### No Pail Low/Empty Sensors

The pump will cavitate. Shut off the air motor immediately.

### With Pail Low/Empty Sensors

“Drum Empty” will appear in the EasyKey status bar. The air motor will shut off and the heat will continue to be applied for approximately 1 hour. The pump icon will flash in the status bar. If the light tower kit is installed a flashing yellow light indicates that the pail is empty and ready to change. In a tandem system a flashing red light means that both pails are empty and the system has shut down.

 In a Tandem system, after a pail change has occurred on the inactive unloader, pressing the

Pump Ready  key will allow five minutes of air to the air motor to allow for the pump to be primed. The inactive unloader must be within its warning deviation setpoints and in the Ready or Heat On state. If the five minute timer runs out before the inactive unloader is primed, pressing the Pump Ready key again will repeat the air to the air motor.

1. Place the ram UP/DOWN lever in the UP position.

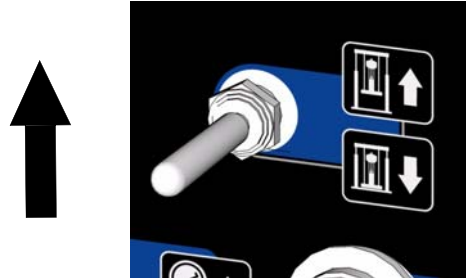

TI8141A

2. Dial ram up regulator pressure to 0 psi.



Excessive air pressure in the material pail could cause the pail to rupture, causing serious injury. The platen must be free to move out of the pail. Attempting to change a pail when the supply unit is cold could result in injury, damage to the equipment, or rupture of the material pail. Never use pail blow-off air with cold adhesive or a damaged pail.

 Positive pressure is released from the pail when the platen seal is pulled clear.

3. Adjust the platen blow-off air regulator (T) to 20-30 psi (138-207 kPa, 1.4-2.1 bar).

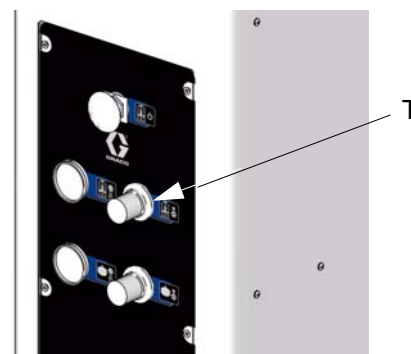

TI8142A

4. Push and hold the blow-off air pushbutton (S). The platen will begin to raise.

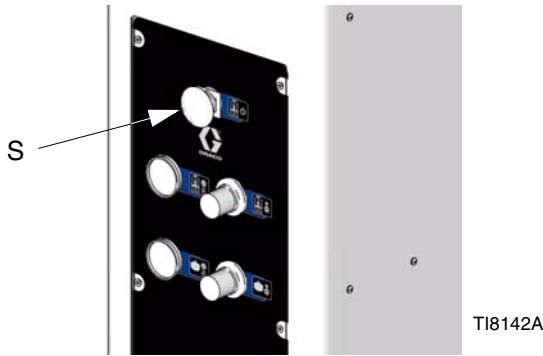



5. When platen is clear of the pail, increase the ram up pressure to 10-15 psi (69-103 kPa, 0.69-1.03 bar) to continue to raise the heated platen.



Never reach under the heated platen after it leaves the pail. Serious burns could result from dripping material.

6. Follow the steps in **Material Loading** (page 22) and **Prime System** (page 24).
7. After pail change, press the Pump Ready key  to reverse the air motor control.
8. Prime the pump.

 It is only necessary to lubricate the platen seals on initial material loading.

 For tandem systems the Pump Ready  key will turn the air motor on for approximately 5 minutes to prime the pump. This can be repeated as necessary.

 If both unloaders in the system are empty, the pump ready and transition sequence will depend on the unloader to transition to the Run state.

✓ Active unloader cleared. Inactive unloader empty.

- Pressing the Pump Ready key  while the active unloader is in the Heat On state will cause the active unloader to transition to the Run state.

✓ Inactive unloader cleared. Active unloader empty.

- Pressing the Pump Ready key  while the inactive unloader is in the Heat On state will cause the inactive unloader to transition to the Ready state. The active state can then be transitioned to the loaded unit.

✓ Both unloaders cleared before pressing Pump Ready.

- Pressing the Pump Ready key  while the inactive unloader is in the Heat On state will cause the inactive unloader to transition to the Ready state. The Pump

Crossover key  must be pressed to transfer active unloader status to the Ready unloader. Pressing the Pump Ready

key  again while the now inactive loader is in the Heat On state, will cause the inactive unloader to transition to the ready state.

- Pressing the Pump Ready key  while the inactive unloader is in the Heat Off state and the active unloader is in the Heat On state will cause the active unloader to transition to the Run state.

- This sequence is required to force the user to only engage one unloader at a time. This prevents accidental pumping of air into the system.

## System Shutdown

Follow the procedure below for normal system shut down, such as at the end of the work day.

1. Make sure the pump rod (PR) is parked in the down position.

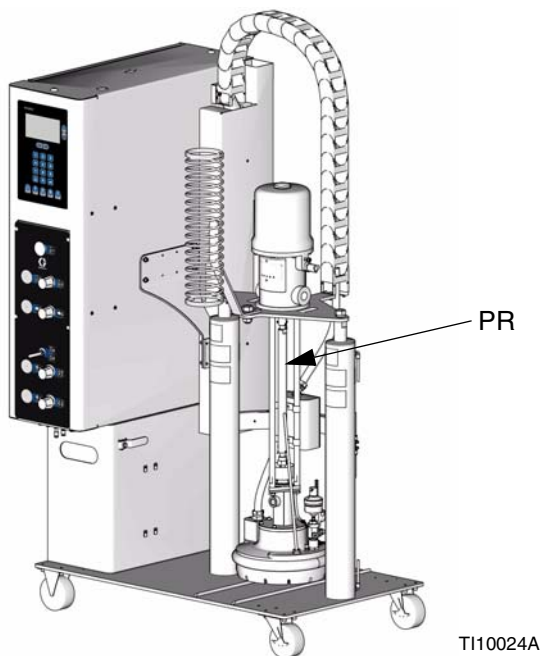

2. Close the system bleed-type master air valve (A).

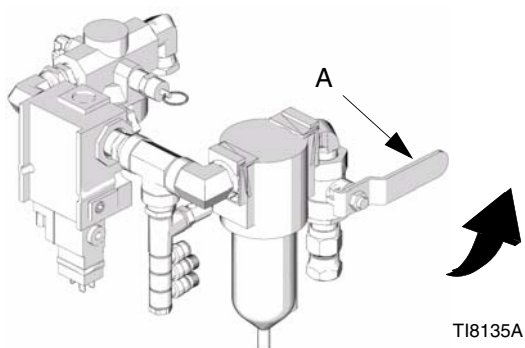

3. Lock the dispense valve trigger open by pulling and securing the trigger retainer (TR).

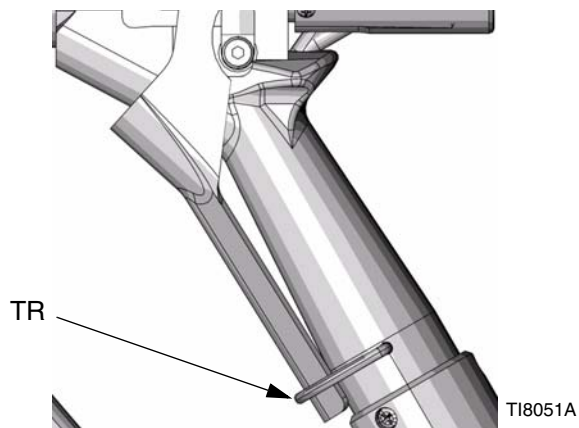

--	--	--	--	--	--	--

Many hot melt materials tend to expand when heating up and may cause a heated hose to burst. Avoid the potential of bursting a hose by opening the dispense valve during system heat up and lock the dispense valve trigger open every time you shut the system down.

4. If the optional 7-day timer is not being used, set the main disconnect to OFF.

 If 7-day timer is required, system needs to be in the system on state.

**POWER  
OFF**

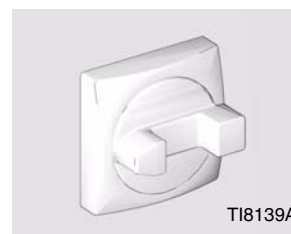

# Dual Ram Cross-Over Installation

## Typical Installation

Part No. 15H385 Cross-Over Cable is included with the Dual Ram.

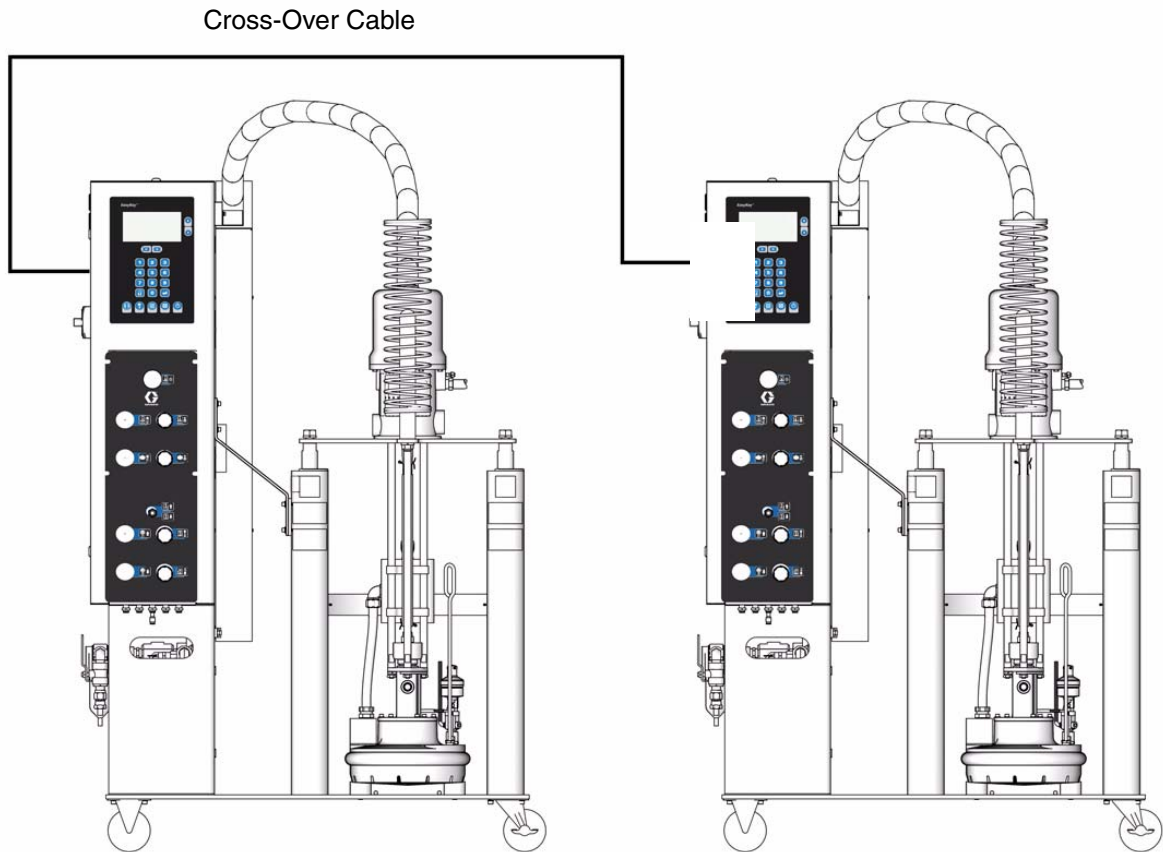

T110074A

### EasyKey Setup

See **EasyKey Display Screens** on page 16.

### Pail Change Procedure

See **Pail Changing** on page 28.

# Maintenance

## Ram

Periodically (at least once a month), inspect the ram guide sleeves, rods and cylinders for wear or damage.

## Ground Fault Interrupt

Periodically (at least once a month) test the ground fault interrupt switch by pushing the TEST button.

## Power in a Tandem System

 In a Tandem System, the secondary unloader provides 24VDC power to the EasyKey display. This allows the primary unloader to be powered down for maintenance without interrupting production. All accessories (light tower, swirl, etc.) and the display board on the primary system will have power when the secondary unloader is powered on and the primary unloader is powered off.

## Resetting the Ground Fault Interrupt

This electrical control panel is equipped with a ground fault interrupt (GFPE) circuit breaker. If the disconnect switch is ON, but all lights on the electrical control panel are off, review troubleshooting procedures.

## Alarm Troubleshooting

The Therm-O-Flow alarms alert you to a problem and help prevent system shut downs or application errors. If an alarm occurs, operation may stop and the following occurs.

- Light Tower Changes (if equipped)
- Status bar on the EasyKey Display shows the description
- Alarm out puts a signal sent to I/O

To Clear the alarm and restart the unit, press the Error

Clear key  on the EasyKey display.

See Table 8, page 33.



Table 8: Therm-O-Flow Alarms

<b>Warnings</b>	
<b>Cause</b>	
	<i>With optional light tower, the yellow light illuminates and green light remains on if in run mode.</i>
	<b>High Temperature</b> - occurs when a zone temperature is above the setpoint plus warning deviation specified in the zone tab of the setup screen.
	<b>Low temperature</b> - occurs when a zone temperature is below the setpoint minus warning deviation specified in the zone tab of the setup screen,
	<b>Drum Low</b> - occurs when the pail low proximity sensor is activated due to the ram position.
<b>Alarms</b>	
<b>Cause</b>	
	<i>With optional light tower, the red light illuminates.</i>
	<b>High Temperature</b> - occurs when a zone temperature is above the setpoint plus alarm deviation specified in the zone tab of the setup screen,
	<b>Low Temperature</b> - occurs when the zone temperature is below the setpoint minus alarm deviation specified in the zone tab of the setup screen while the unloader is in the run state.
	<b>Sensor Error</b> - occurs in the following conditions when an enabled zone does not increase in temperature within two minutes while the system is in the Heat On state. This is the short circuit state of an RTD sensor. Or when a zone temperature exceeds 500°F (260°C). This is the open circuit state of an RTD sensor
	<b>Heat Control Error</b> - occurs if the conductor relay on a temperature board is not closed when a zone of the temperature board is enabled and in a heat state for the active unloader,
	<b>Communication Error</b> - there are two possibilities: <ul style="list-style-type: none"> <li>• Start up - Occurs if the EasyKey display board cannot communicate with any board in the system.</li> <li>• Normal Operation - occurs if any board in the system, including tandem unloader, cannot communicate with the EasyKey Display board.</li> </ul>
<b>Events</b>	
<b>Cause</b>	
	<b>Drum Empty</b> - occurs when the pail empty proximity sensor is activated for the ram position.
	<i>With optional light tower the yellow light begins flashing and the green light turns off.</i>
	<b>Maintenance Call</b> - occurs in advanced unit if user presses maintenance call button. See “Maintenance Call Kit (253548)” on page 63 for additional information.
	<i>With optional light tower the yellow light turns on.</i>
	<i>See “Light Tower Kit (253547)” on page 53 for additional information.</i>

# Ram Troubleshooting

Problem	Cause	Solution
Ram will not raise or lower.	Closed main air valve or clogged air line,	Open air valve; clear air line.
	Not enough ram air pressure.	Increase ram air pressure.
	Worn or damaged ram piston.	Replace piston. See instruction manual 310525.
	Platen not fully up to temperature.	Wait for full temperature.
	Ram air pressure too high.	Decrease ram air pressure.
	Dented pail has stopped platen.	Fix or replace pail.
Ram raises or lowers too fast.	Ram "up / down" air pressure too high.	Decrease ram air pressure.
Air leaks around cylinder rod.	Worn rod seal.	Replace o-rings in guide sleeve. See instruction manual 310525.
Fluid squeezes past platen wiper.	Ram air pressure too high.	Decrease ram air pressure.
	Worn or damaged wiper.	Replace wiper.
	Directional valve not in the down position.	Position handle in the down position.
Pump will not prime properly, or pumps air.	Closed main air valve or clogged air line.	Open air valve; clear air line.
	Not enough air pressure.	Increase air pressure.
	Worn or damaged ram piston.	Replace piston. See instruction manual 310525.
	Ram directional valve closed or clogged.	Open valve; clear valve or exhaust.
	Ram directional valve dirty, worn, or damaged.	Clean; repair valve.
	Dented pail has stopped platen.	Fix or replace pail.
Air pressure will not push platen out of pail.	Closed main air valve or clogged air line.	Open air valve; clear air line.
	Not enough blow-off air pressure.	Increase blow-off air pressure.
	Blow-off valve passage clogged.	Clean valve passage.
	Dented pail has stopped platen.	Fix or replace pail.
	Wiper bonded to pail or pail liner.	Lubricate wiper with high temperature grease at every pail change.

## Pump Troubleshooting

For additional troubleshooting information about the pump, see the pump's documentation.

Problem	Cause	Solution
Rapid downstroke or upstroke (pump cavitation).	Air is trapped in pump.	Bleed air from pump. See <b>Prime System</b> , page 24.
	Downstroke: Dirty or worn pump intake valve.	Clean or repair. See Pump Manual.
	Upstroke: Dirty or worn pump piston valve.	Clean or repair.
Material leaks around pump outlet.	Loose outlet fitting.	Tighten outlet fitting.
Material leaks around bleed port.	Loose bleed port fitting.	Tighten bleed port fitting.
Pump will not move up and down.	Problem with air motor.	See Air Motor Manual.
	Foreign object lodged in pump.	Relieve pressure. See Pump Manual.
Leak around pump wet-cup.	Worn throat seals.	Replace throat seals. See pump manual.

## Air Motor Troubleshooting

For additional air motor troubleshooting information, see the air motor manual supplied.

Problem	Cause	Solution
Air motor stalled	Main air valve is dirty or damaged	Clean/rebuild main air valve.
Air continually exhausting around air motor shaft	Air motor shaft seal is damaged	Replace air motor shaft seal.
Air continually exhausting around the air valve/slide valve	Air valve/slide valve gasket is damaged	Replace the valve gasket.
Air continually exhausting from muffler while the motor is idle	Internal seal damage	Rebuild air motor.
Oil leaking from exhaust port	Too much lubricant mixed in with the air supply	Reduce lubricant supply.
Frost build-up on muffler	Air motor operating at too high a pressure or cycle rate	Reduce air motor pressure, cycle rate, or duty cycle.



# Electrical Control Panel Troubleshooting

Problem	Cause	Solution
Disconnect is ON, but EasyKey not lit.	The ground fault interrupt has been activated.	Have a qualified electrician check wiring.
	One or more fuses or circuit breakers tripped.	Have a qualified electrician check wiring.
High temperature alarm.	The temperature of a heated component has gone out of range.	Supply unit automatically turns off power to supply unit components and air motor. Unit turns power back on when overheated components reach appropriate temperatures.
Heat is turned off after a period of pump inactivity.	Pump has not moved within the programmed time period and the inactivity timer has been triggered.	See Table 7, page 21.
Pump Ready key does not clear flashing pump ready icon.	Unloader not in Heat On state and/or zones have not reached warning deviation level.	Turn system to Heat On state and wait until all zones reach warning deviation level.



# Service

## Ram

						
Whenever you service the ram, follow the <b>Ram Pressure Relief Procedure</b> on page 27.						

Periodically (once a month), inspect the ram guide sleeves, rods and cylinders for wear or damage, replace all worn parts. See the **Service** section of Form 310525 for instructions on replacing worn parts.

## Pump

See the material pump instructions for its inspection frequency.



## Ground Fault interrupt

Periodically (at least once a month) test the ground fault interrupt switch by pushing the TEST button.

## Power in a Tandem System

 In a Tandem System, the secondary unloader provides 24VDC power to the EasyKey display. This allows the primary unloader to be powered down for maintenance without interrupting production. All accessories (light tower, swirl, etc.) and the display board on the primary system will have power when the secondary unloader is powered on and the primary unloader is powered off.

## Platen Service

						
-----------------------------------------------------------------------------------	-----------------------------------------------------------------------------------	------------------------------------------------------------------------------------	--	--	--	--

 Raise the platen up out of the pail before proceeding. See **Pail Changing** on page 28.

## Removing the Platen

1. Turn OFF the main electrical disconnect.
2. Disconnect the platen power wires and the platen ground wire from within the main control panel and pull out of conduit.
3. Remove the platen assembly from the ram.
4. Reverse this procedure to reinstall the new or rebuilt platen assembly.

## Replacing Wiper

1. Follow **Pressure Relief Procedure**, page 26.
2. Separate the wiper joint, and bend back the strapping that covers the clamp (207). FIG. 21.
3. Unscrew the worm gear and remove the wiper (202).
4. Thread the strapping through the new wiper (202).
5. Insert the strap end through the clamp (207) and tighten.
6. Use a rubber mallet to pound the wiper around the platen (201) until the wiper ends are butted tightly together.
7. Apply a lubricant to the wiper (202). Use a lubricant that is compatible with the material to be pumped. Check with the material supplier.

## Replacing Platen Heat Sensor

1. Follow **Pressure Relief Procedure**, page 26.
2. Make sure the ram control lever is set to OFF.
3. Turn OFF the main electrical disconnect.
4. Remove the cover from the junction box (31). Disconnect quick connect terminal (233) inside the box.
5. Loosen the conduit locknut on sensor (219). FIG. 21. Unscrew the sensor from the platen.
6. Coat the new sensor with non-silicone heat-sink compound.
7. Slide the sensor (219) into the opening in the platen (201). Be sure it is seated to the bottom of the platen.
8. Tighten the conduit locknut on the sensor.

9. Reconnect the quick connect terminal (233) inside the junction box (31). Reinstall the junction box cover.

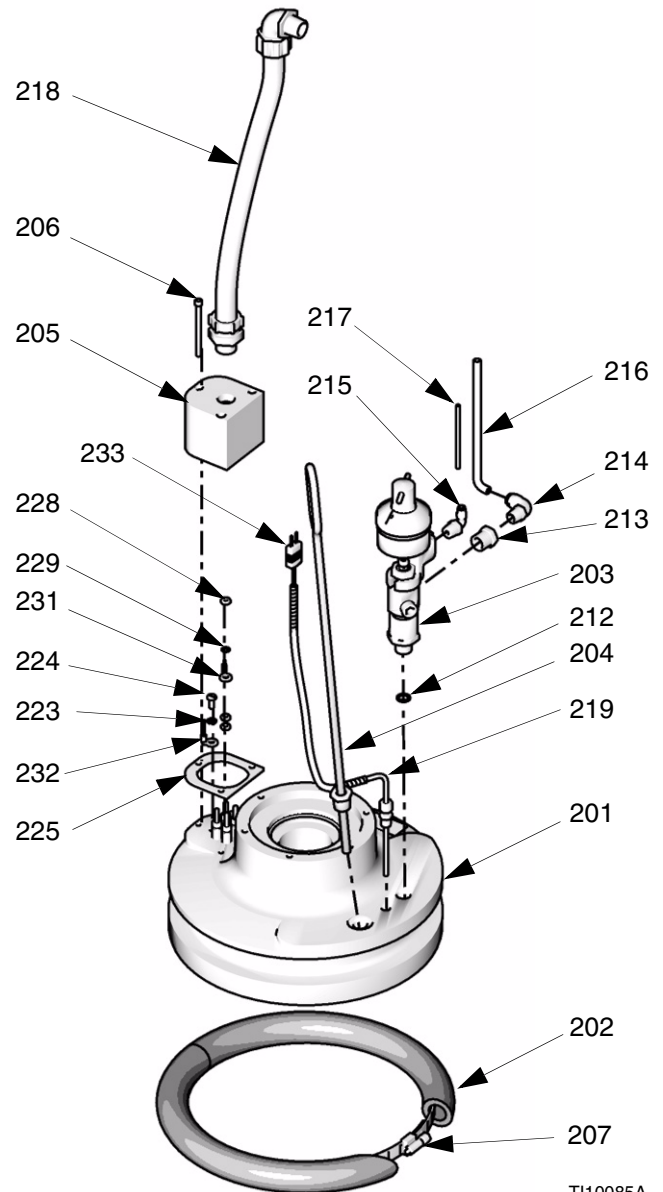

T110085A

**FIG. 21: Platen**



## Air Motor/Pump Removal and Service

						
<b>This procedure must be done with the unit still warm. The material and equipment will be hot!</b>						

For information about servicing the Mini-5 Pump, see pump manual 307431.





For information about servicing the President air motor, see air motor manual 306982.

1. Remove the material pail (see **Pail Changing** procedure on page 28). Ensure that the air motor shaft is fully extended and the pump rod is in the fully down (parked) position.
2. Make sure the platen is down and the ram up/down lever is in the neutral position.

						
Follow the <b>Pressure Relief Procedure</b> on page 26 when you stop spraying and before cleaning, checking, servicing, or transporting equipment.						

3. Bleed off excess material and pressure in the system by opening the dispense gun and catching the material in a waste container.
4. Press  to turn off the system heat.
5. Turn OFF the main electrical power supply to the unit. Follow all applicable safety procedures and lockout rules.

6. Turn OFF the main electrical disconnect (K) located on the left side of the Therm-O-Flow 20.

						
Make sure the main disconnect is off before continuing with this procedure.						

7. Disconnect all material hoses.
8. Remove air line from air motor and air lines to the platen blow-off valve.
9. Remove nuts (105) from tie rods at the pump end. See FIG. 22.
10. Remove the screws (36) and washers (22) holding the pump adapter (107) to the platen.
11. Remove the cover from the junction box (31). Remove the screws holding the junction box to the tie rods (104).
12. Fully loosen coupler (111) from the pump rod (G).
13. Slowly raise elevator to achieve enough separation of the tie rods to remove the pump.
14. Remove the pump.
15. Reverse this procedure to reinstall the new or rebuilt pump.



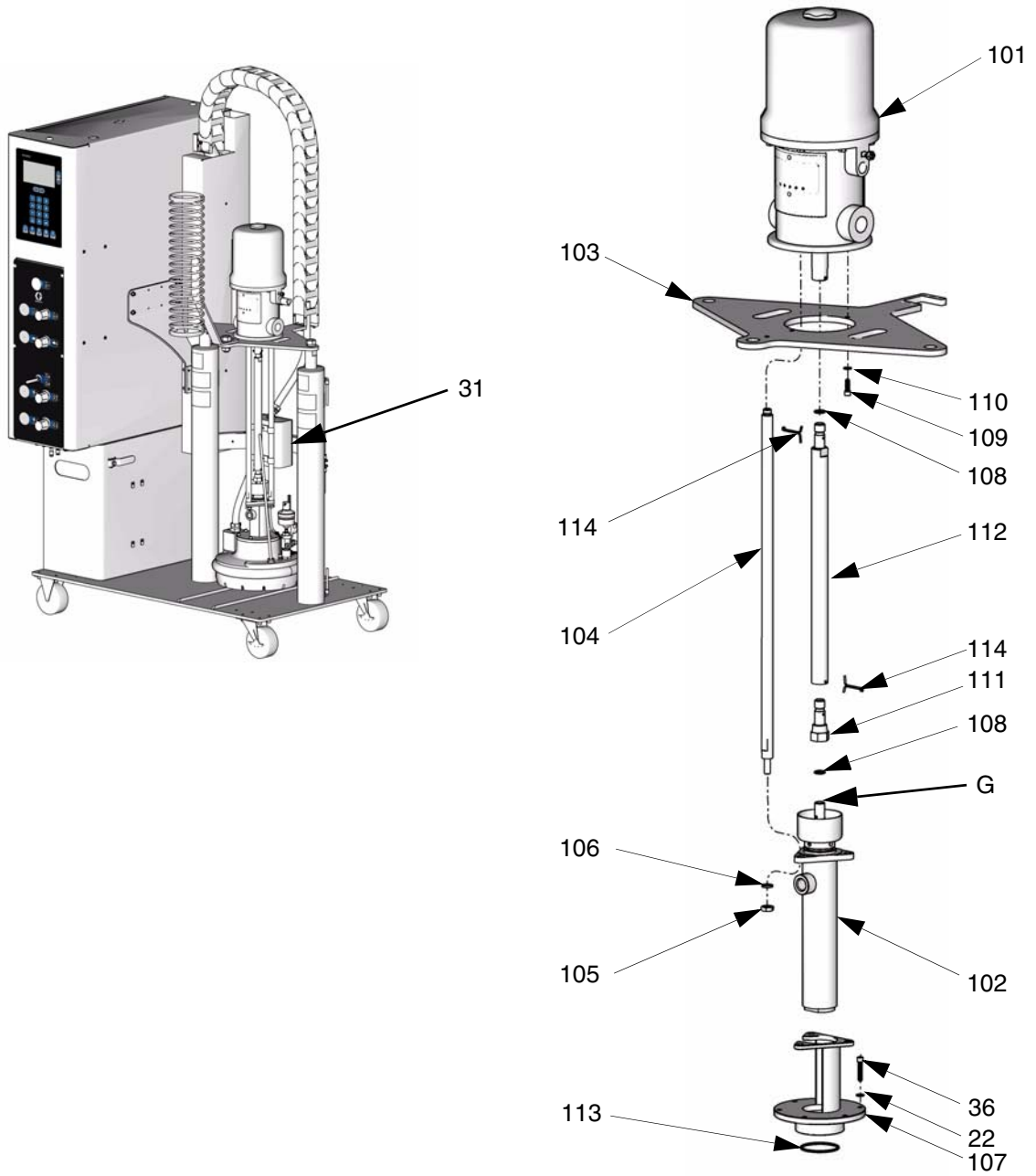

T110203A

FIG. 22

# Parts

## Therm-O-Flow 20

Ref	Part	Description	Qty	Ref	Part	Description	Qty
				22	100016	WASHER, lock; 1/4; units with controls	14
1	277436	CART, assembly	1				
2*	288544	PEDESTAL, enclosure	1		100016	WASHER, lock; 1/4; units without controls	10
3*	288671	CONTROL, standard, 230v, 4 zone	1				
	288673	CONTROL, secondary, 230v, 4 zone	1	23	112166	SCREW, cap, socket-hd; 1/4-20 x 3/4 in. (19 mm)	4
	288672	CONTROL, standard, 480v, 4 zone	1	24	110755	WASHER, plain; units with controls	8
	288674	CONTROL, secondary, 480v, 4 zone	1		110755	WASHER, plain; units without controls	4
4	253137	CONTROL, air, assy; units with controls; see page 46	1	25	100020	WASHER, lock; units with controls	10
	297401	CONTROL, air, assy; units without controls; see page 46	1		100020	WASHER, lock; units without controls	2
5	288505	PUMP, President; see page 44	1	26*	111820	SCREW, cap, socket-hd; 10-24 x 3/4 in. (19 mm)	6
6	288511	PLATEN, heated, finned; see page 45	1	28	100179	NUT, hex; 10-24; units with controls	6
	288512	PLATEN, heated, smooth; see page 45	1		100179	NUT, hex; 10-24; units without controls	2
7	154628	WASHER	1	29	114003	VALVE, safety	1
8	516587	BOLT, 3/4-10x1.5 hex head	1	30	120774	ADAPTER, reducing, 5/16 to 1/4 tube	2
9	101015	WASHER, lock	1	31	288689	JUNCTION box, main body	1
10	C19187	NUT	1	32	288728	BRACKET, mounting, junction box	2
11*	120187	SCREW, button head; 1/2-13 x 3/4 in. (19 mm)	2	33	288690	JUNCTION BOX, front cover	1
12*	288738	CONDUIT, w/fittings	1	34	120792	FASTENER, thread-cutting screw	2
13	288540	BRACKET, enclosure, ram	1	35	120795	FITTING, push-in romex connector	1
14*	218093	HOSE; 1/2 npt (mbe); 22 in. (560 mm)	1	36	103345	SCREW, cap, socket-hd; 1/4-20 x 1-1/4 in. (31 mm)	6
15	253229	HOSE, air; 1/2 npt (mbe); 15 ft (4.6 m)	1	37*	120809	FITTING, washer, reducing, 1 in. to 1/2 in.	2
	205418	HOSE, air; 1/2 npt (mbe); 6 ft (1.8 m)	1	39*	100643	SCREW, cap, socket-hd; 1/4-20 x 1 in. (25 mm)	4
16	288543	BRACKET, hose spring	1	43	112756	SCREW, cap, socket-hd; 10-24 x 1-1/4 in. (31 mm)	4
17*	288517	CABLE, track	1	44	155470	UNION, swivel; 1/2 npt(m) x 1/2 npsm(f)	1
18*	288634	BRACKET, cable track-enclosure	1				
19*	100214	WASHER, lock	8				
20*	101864	SCREW, cap sch	12				
21*	100023	WASHER, flat	4				

\* These parts are used only on complete systems with controls.

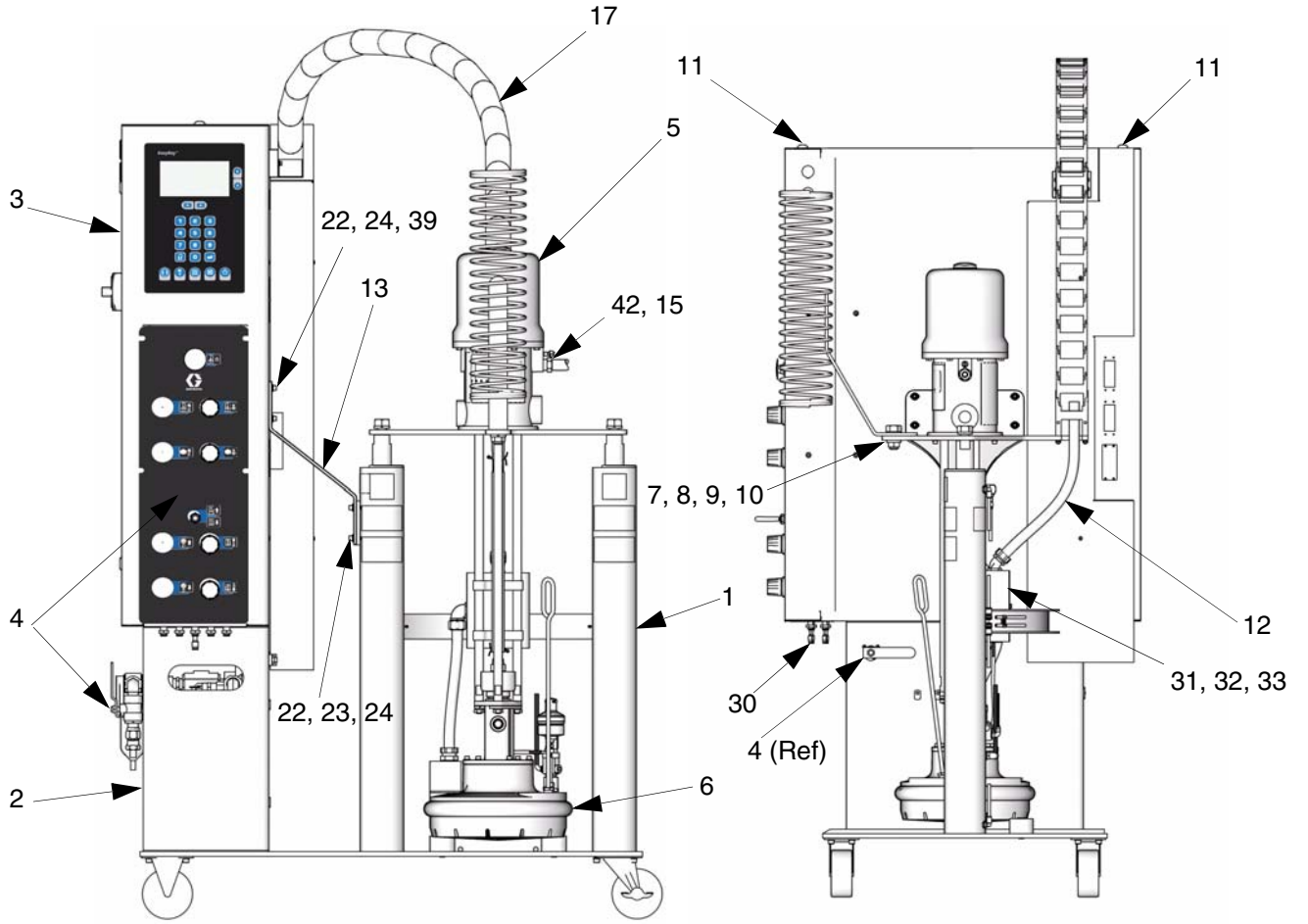

TI10025A

TI10027A

# Pump

Ref	Part	Description	Qty
101	207352	MOTOR, air, President; see 306982	1
102	918417	PUMP, Mini-5; see 307431	1
103	288635	PLATE, mounting	1
104	198369	ROD, tie	3
105	100340	NUT	3
106	100133	WASHER, lock	3
107	298073	ADAPTER, pump	1
108	156082	O-RING	2
109	112166	SCREW, cap, SCH	2
110	100016	WASHER, lock	2
111	207370	ROD, connecting	1
112	198412	ROD, connecting	1
113	C38225	O-RING	1
114	101946	PIN, cotter, SST	2
117	206994	TSL, 8 oz bottle	1

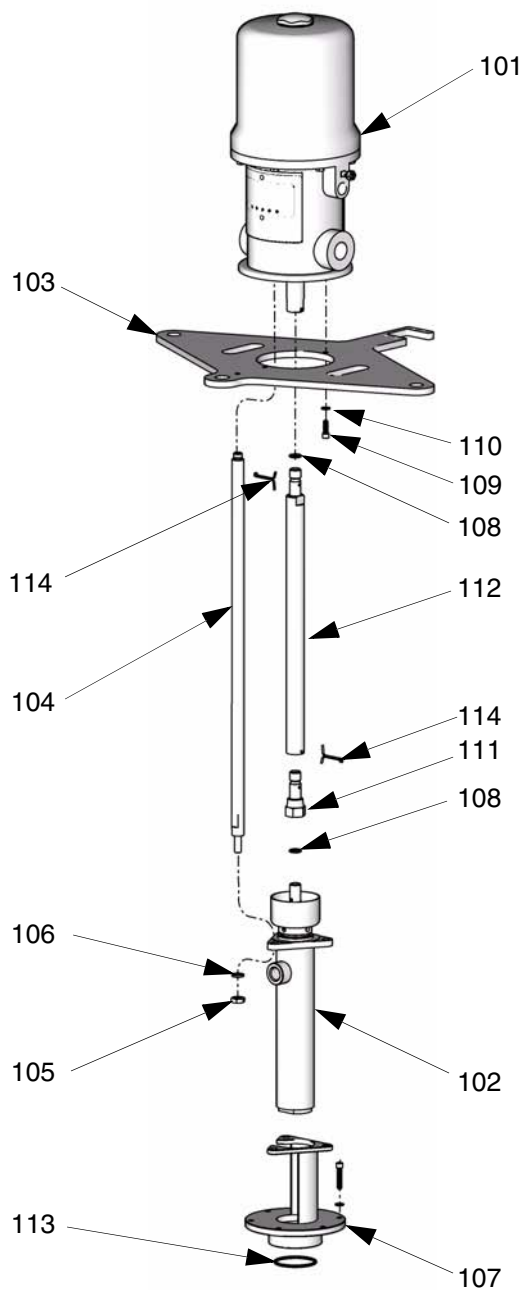

T110203A

# Platen

Ref	Part	Description	Qty
201	288509	PLATE, heated, finned; used on 288511	1
	288510	PLATE, heated, smooth; used on 288512	1
202	C31052	HOSE, seal, Mini - 5	1
203	207440	VALVE, dispenser	1
204	288855	HANDLE, bleed	1
205	15J794	ADAPTER, bushing	1
206	514930	SCREW, cap, skt hd	3
207	C31154	CLAMP, worm gear	2
212	167730	GASKET, copper	1
213	100176	BUSHING, hex	1
214	115948	ELBOW, 1/4 npt(m), 5/16 OD tube	1
215	115949	ELBOW, 1/4npt(m), 5/32 OD tube	1
216	054778	TUBE, PTFE, 1/4 x 5/16	13
217	054779	TUBE, PTFE, 3/32 x 5/32	13
218	288524	CONDUIT, hi-temp, w/fittings	1
219	15K032	SENSOR, RTD, temp, w/connector	1
223	C38163	WASHER, lock, ext. tooth	1
224	C19049	SCREW, mach, slotted, rnd hd	1
225	15C171	GASKET	1
228	102931	NUT, mach. hex	4
229	120866	WASHER, lock, internal tooth	4
231	15K035	CONDUCTOR, heater	4
232	15K036	CONDUCTOR, ground	1
233	15K034	CONDUCTOR, RTD, temp w/ connector	1

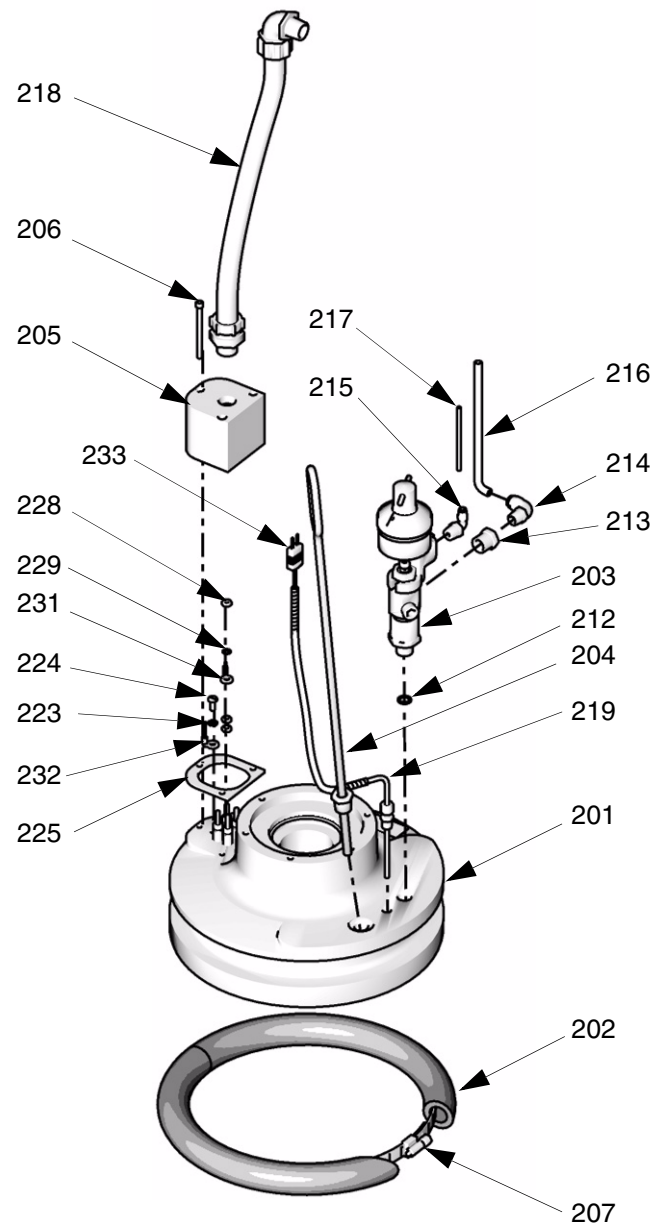

TI10085A

## Air Control

Ref	Part	Description	Qty	Ref	Part	Description	Qty
308	113269	VALVE, ball, bleed-type; 1/2 npt	1	315	C11033	FILTER, air	1
309	113286	VALVE, safety	1	316	120434	SOLENOID, motor 24V dc	1
310	115952	VALVE, 4-way, 1/8 npt	1	317	120435	REGULATOR, remote piloted	1
311	120432	REGULATOR, panel mount	4	318	15H236	VALVE, ball, female, 1/2 npt	1
312	115957	VALVE, check	4	319	C06299	MUFFLER, #10-32 unf	2
313	115948	ELBOW, 1/4 npt(m), 5/16 OD tube	3				
314	C11037	INSERT, 1/2 npt	2				

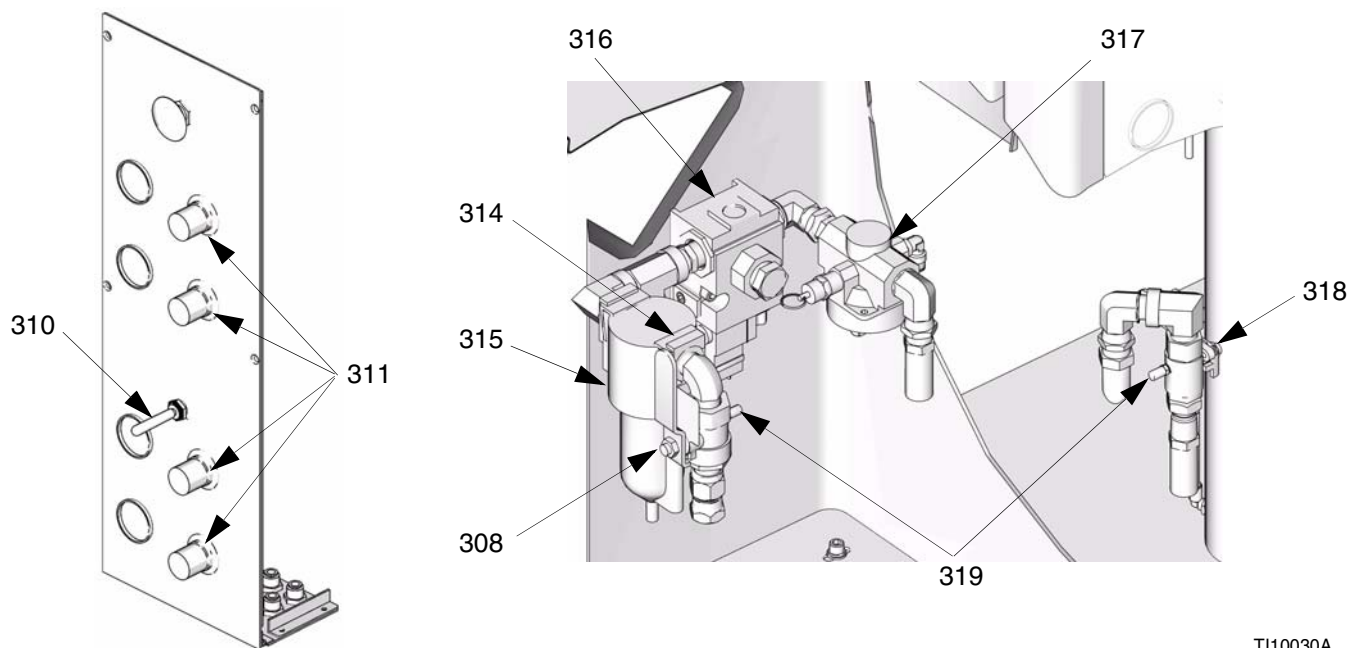

T110030A

# EasyKey Assembly, Part No. 255224

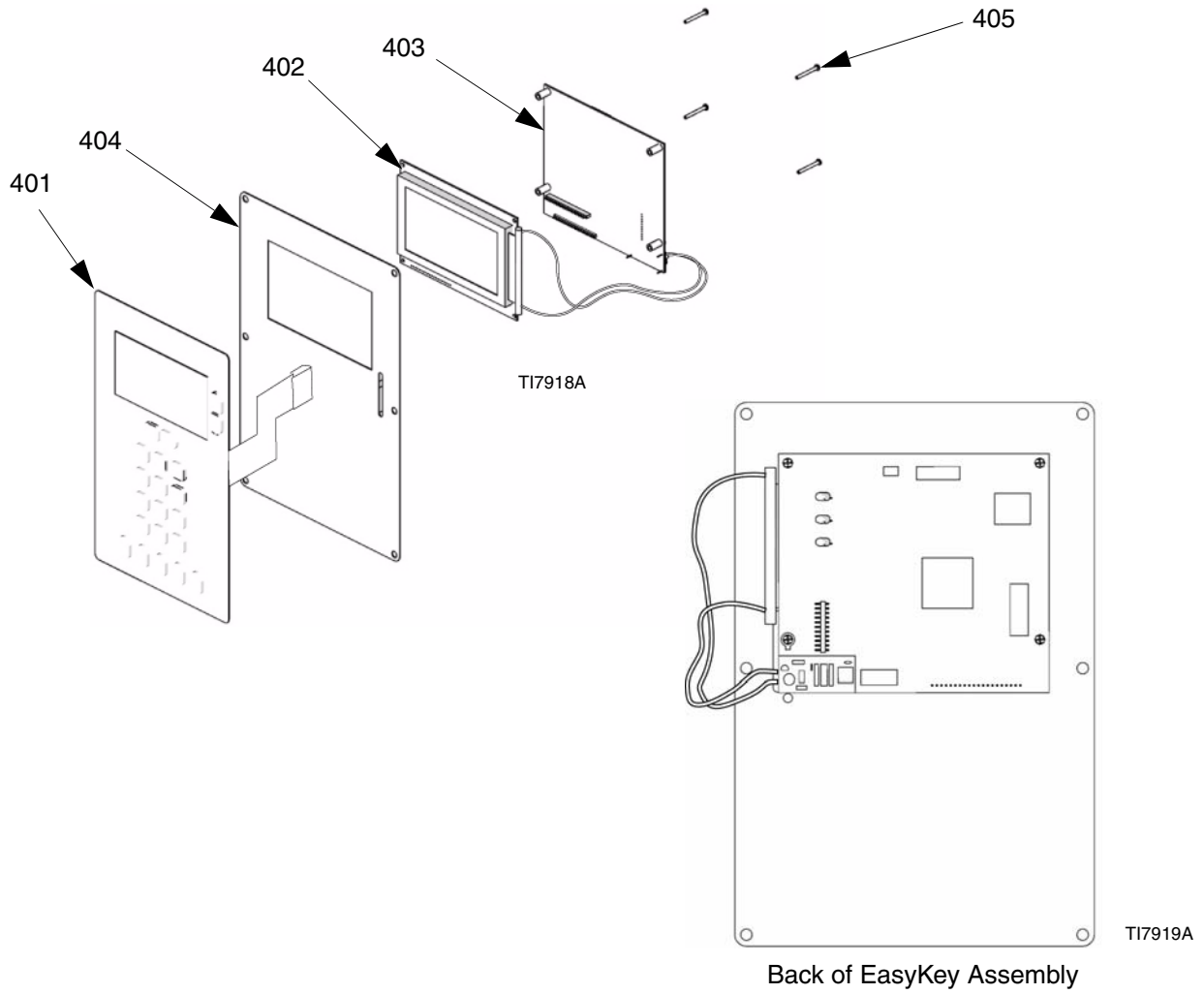

Ref No.	Part No.	Description	Qty
401		LABEL, operations	1
402	117769	DISPLAY, graphics	1
403		BOARD, circuit assembly	1
404		PLATE, blank	1
405		SCREW, pan head cross 4-40	4

## Spare Parts and Kits

<b>Spare Parts and Kits</b>	
<b>Graco Part No.</b>	<b>Description</b>
See manual 307431	Pump Rebuild Kit
253566	Ethernet Kit
255224	EasyKey Display Kit
117769	LCD Graphic Display
253603	Pail Low and Empty Sensors
253547	Light Tower Kit
120400	Discrete I/O Cable
15H385	Crossover Communication Cable
120384	Swirl Cable
15K032	Platen RTD Sensor
253548	Maintenance Call Button Kit
253567	Discrete I/O Kit
255233	Pail Low and Empty Sensor Kit
288511	Platen Assembly, Finned
288512	Platen Assembly, Smooth
288543	Hose Support Kit
C31065	Wiper Repair Kit

<b>Electrical Control Panel Spare Parts</b>			
<b>Reference No.</b>	<b>Graco Part No.</b>	<b>Description</b>	<b>4 Zone</b>
PCB246	249404	Unloader Board	1
PCB201	249405	Temperature Board	2
SR100, 113, 116, 119	120398	18 amp Watlow SSR	5
DISC 100		Disconnect 30A	
N/A	120439	Door Operating Mech - Disconnect	1
N/A	120440	Shaft Disconnect	1
FU1061, 1062	116214	15A Fuse	2
FU106, 108	120426	7A Fuse	2
FU113, 119	116208	6A Fuse	2
FU116, 122	116209	2-1/4A Fuse	2
PS122	120427	DC Pwr Supply 24V	1
GFPE112	120428	GFPE	1
N/A	120430	5KVA Transformer	1



# Electrical Schematics

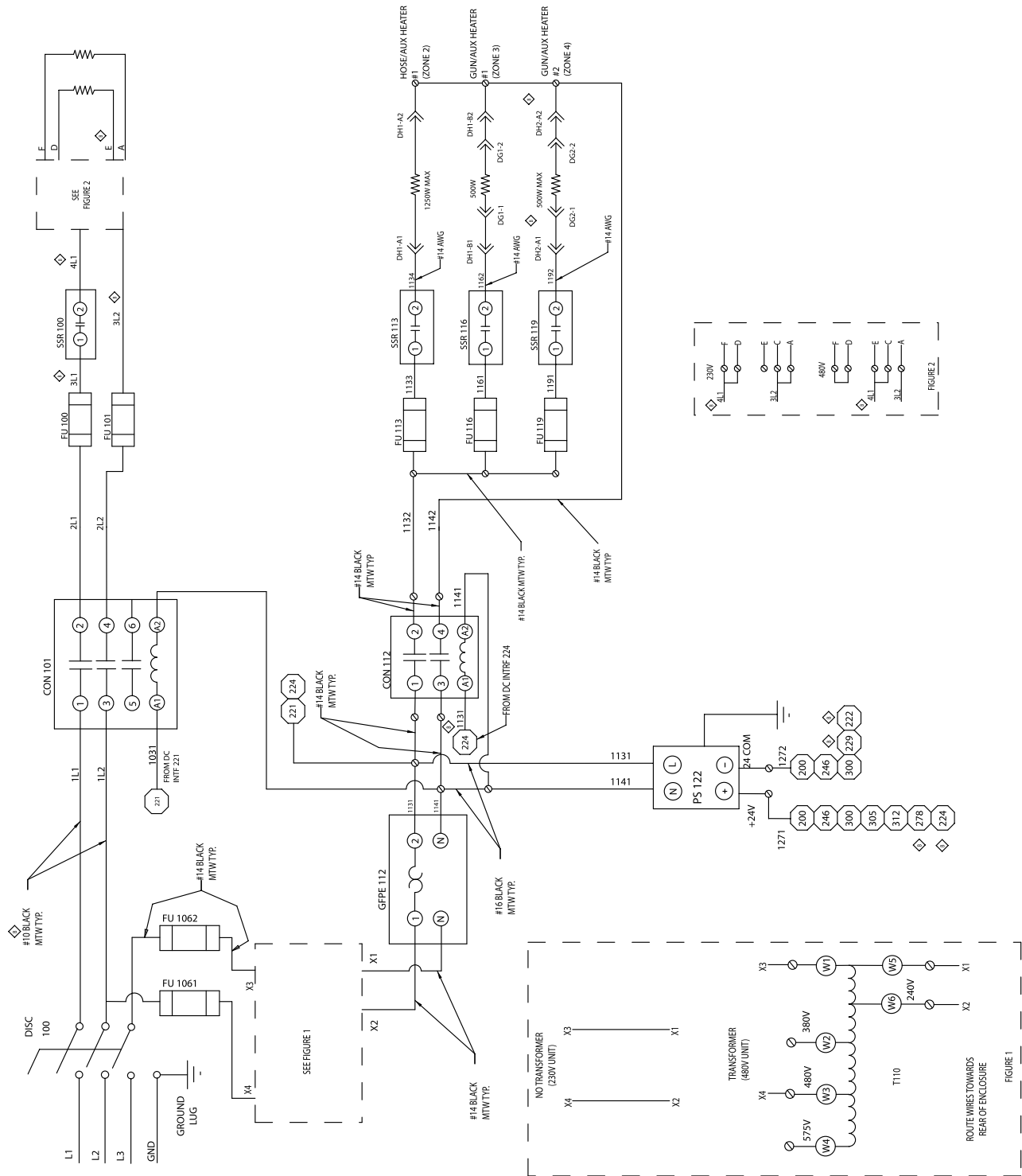

100

101

102

103

104

105

106

107

108

109

110

111

112

113

114

115

116

117

118

119

120

121

122

123

124

125

126

127

128

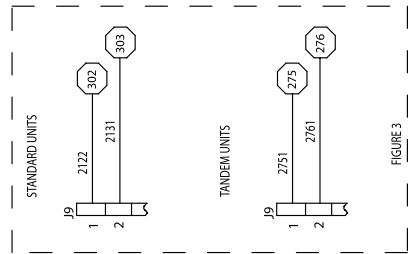
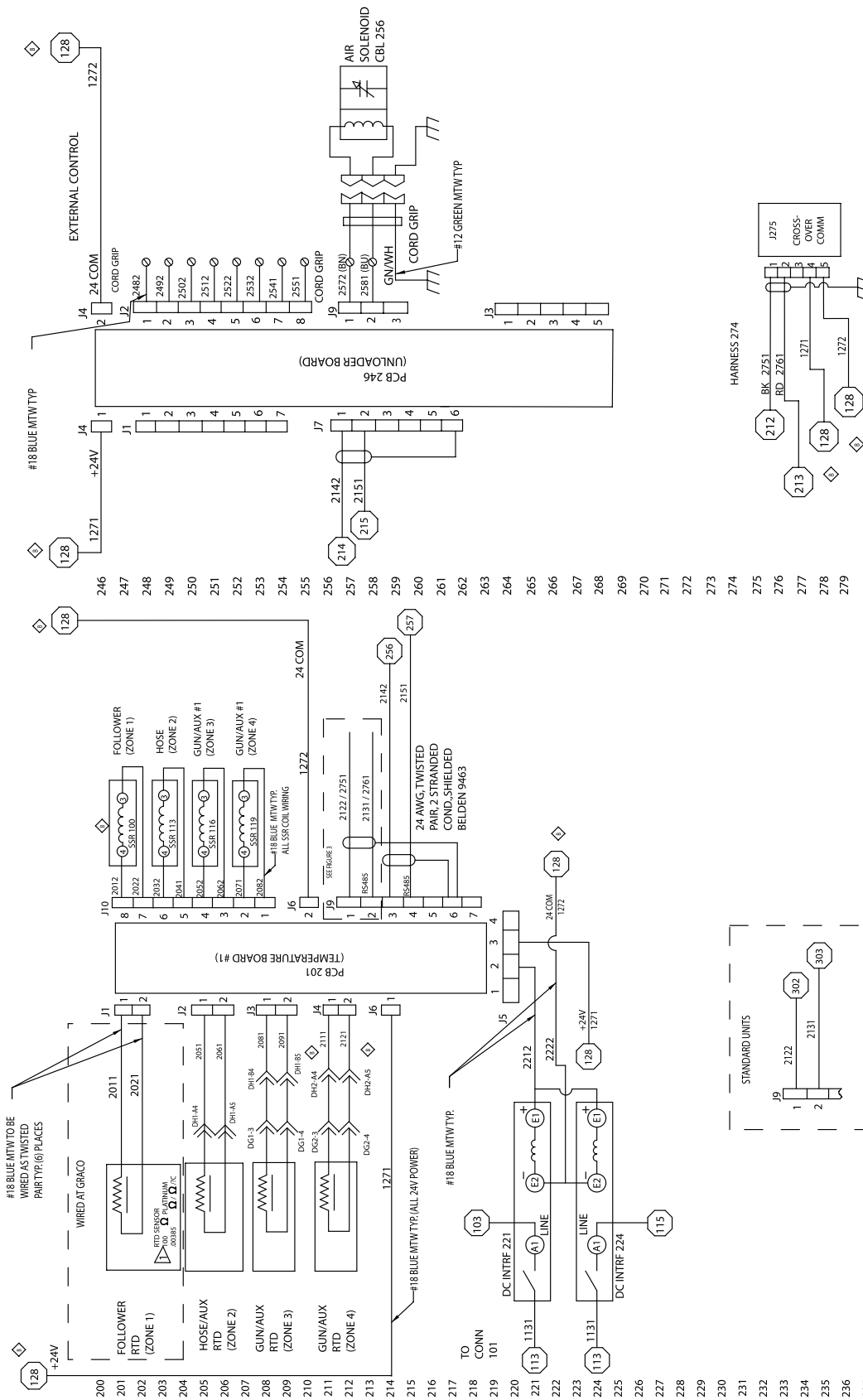
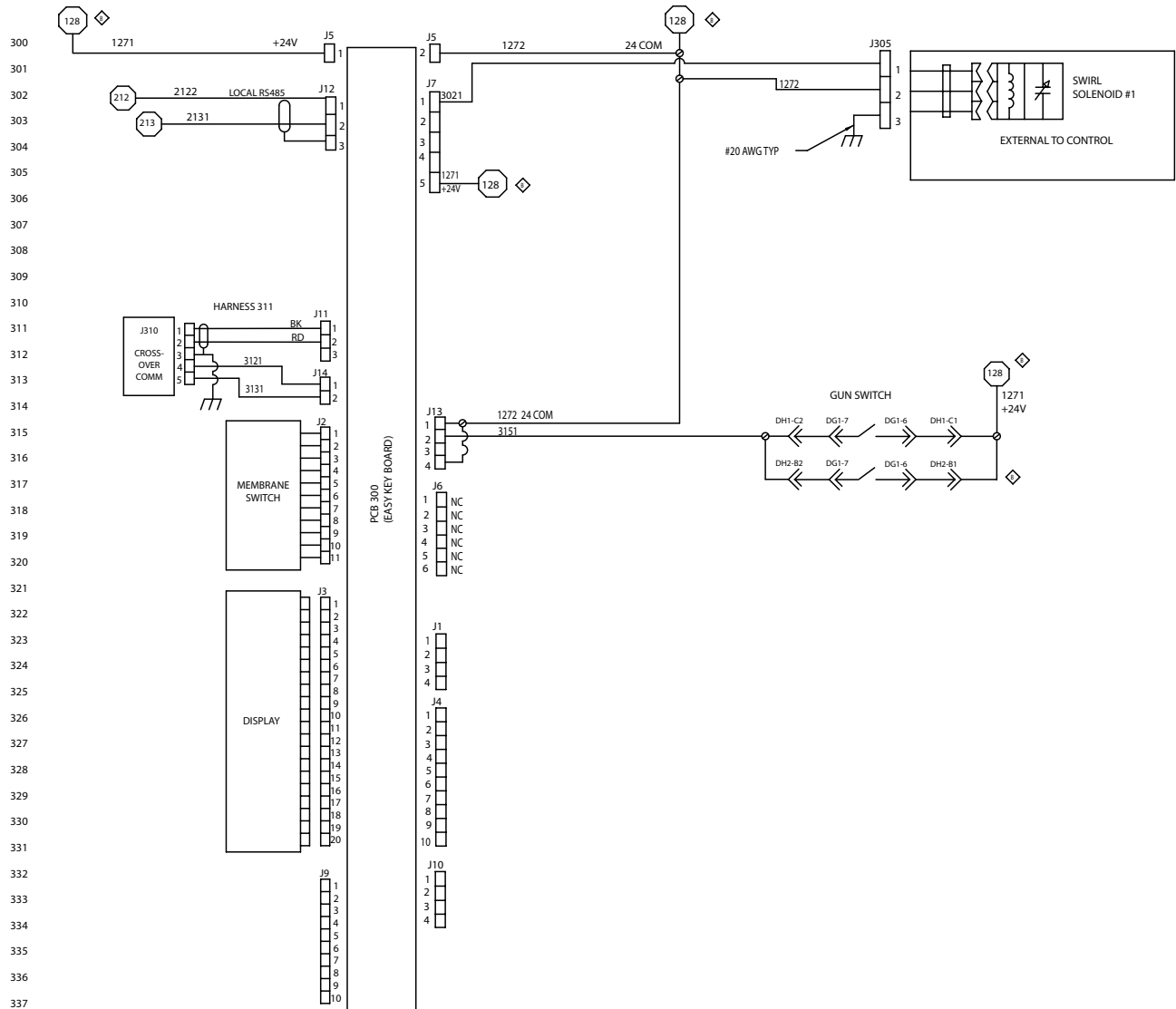
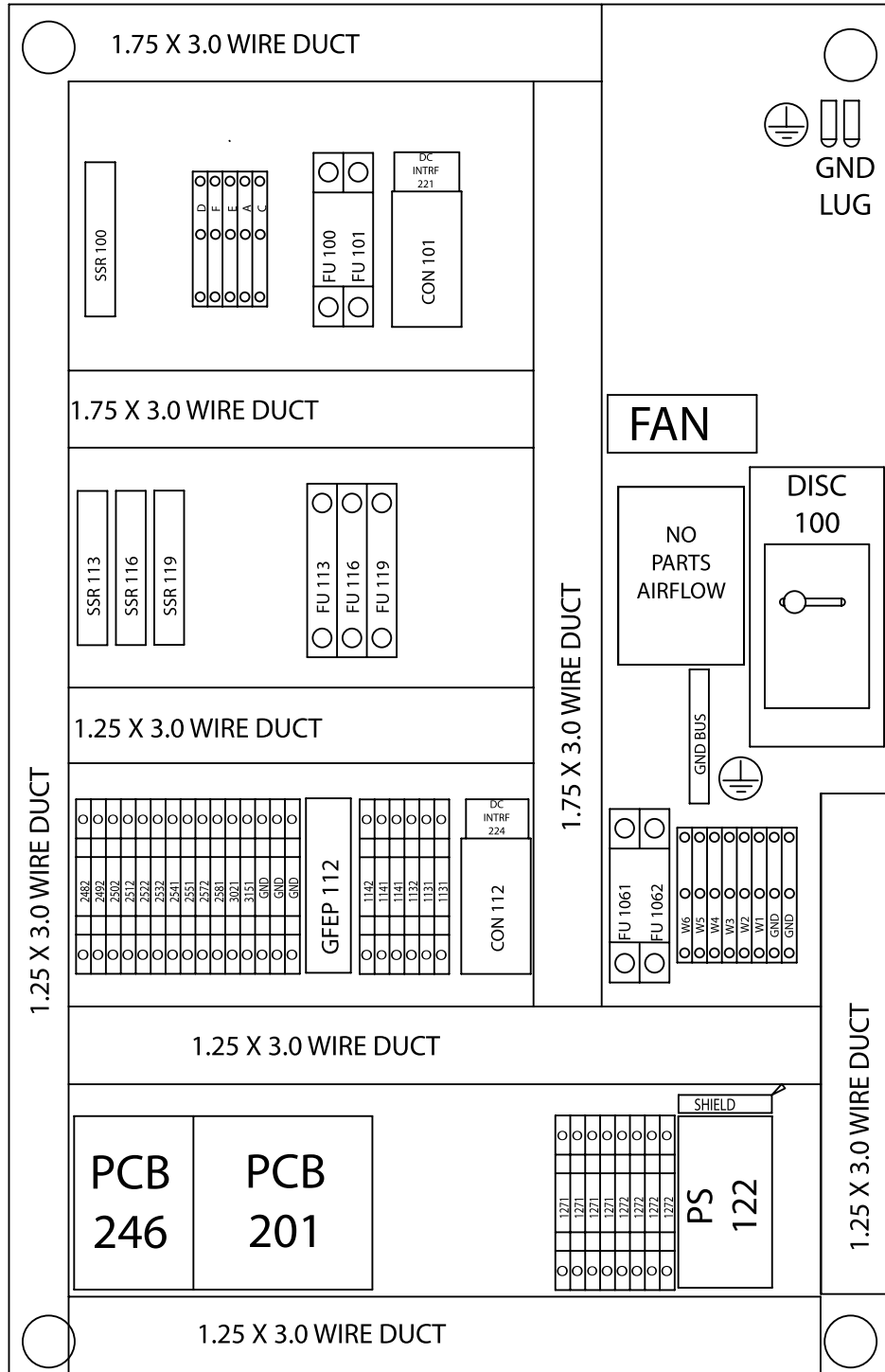

FIGURE 3





# Accessories

## Light Tower Kit (253547)

The optional light tower kit has the following color and flashing lights to signal warnings and alarms. See FIG. 23.

**Green** denotes an active system where the pump will activate when material is needed.

**Yellow** denotes user attention is required.

**Flashing yellow** denotes a pail is empty (when equipped with proximity sensors).

**Red** denotes immediate user attention is required due to an alarm condition or interruption of material flow. The user should be aware that in the case of a motor error on a Single or Tandem system, or a Tandem system with both pails empty, heat may be applied to the platen and pump to allow for a pail change.

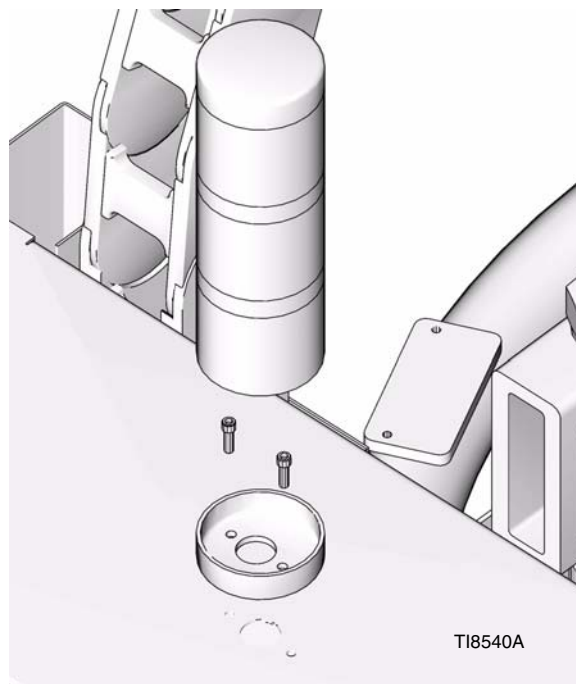
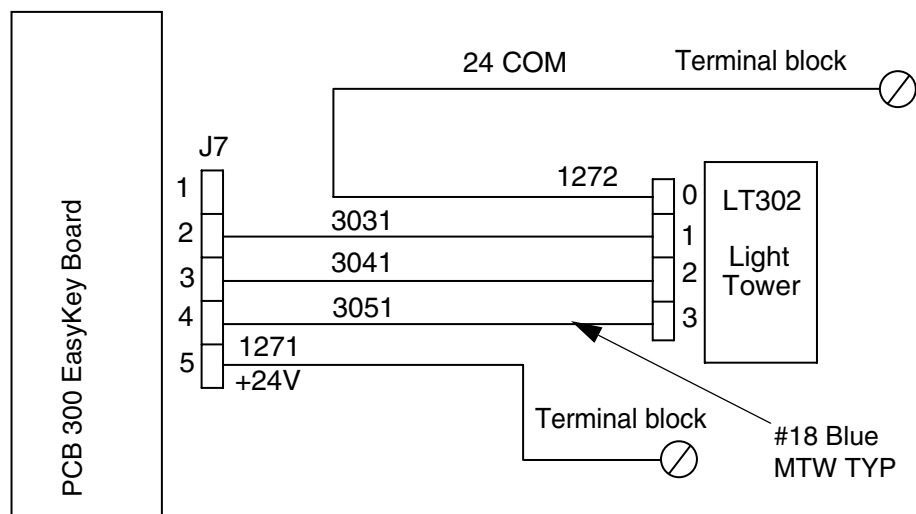





FIG. 23: Light Tower Kit



TI8523A mod

FIG. 24: Light Tower Schematic

- KEY:
-  Wired at Graco: back and top of wire track.
  -  High Voltage: Back and top or right of wire track.
  -  Low Voltage (+24V or less): Front and bottom or left of wire track.

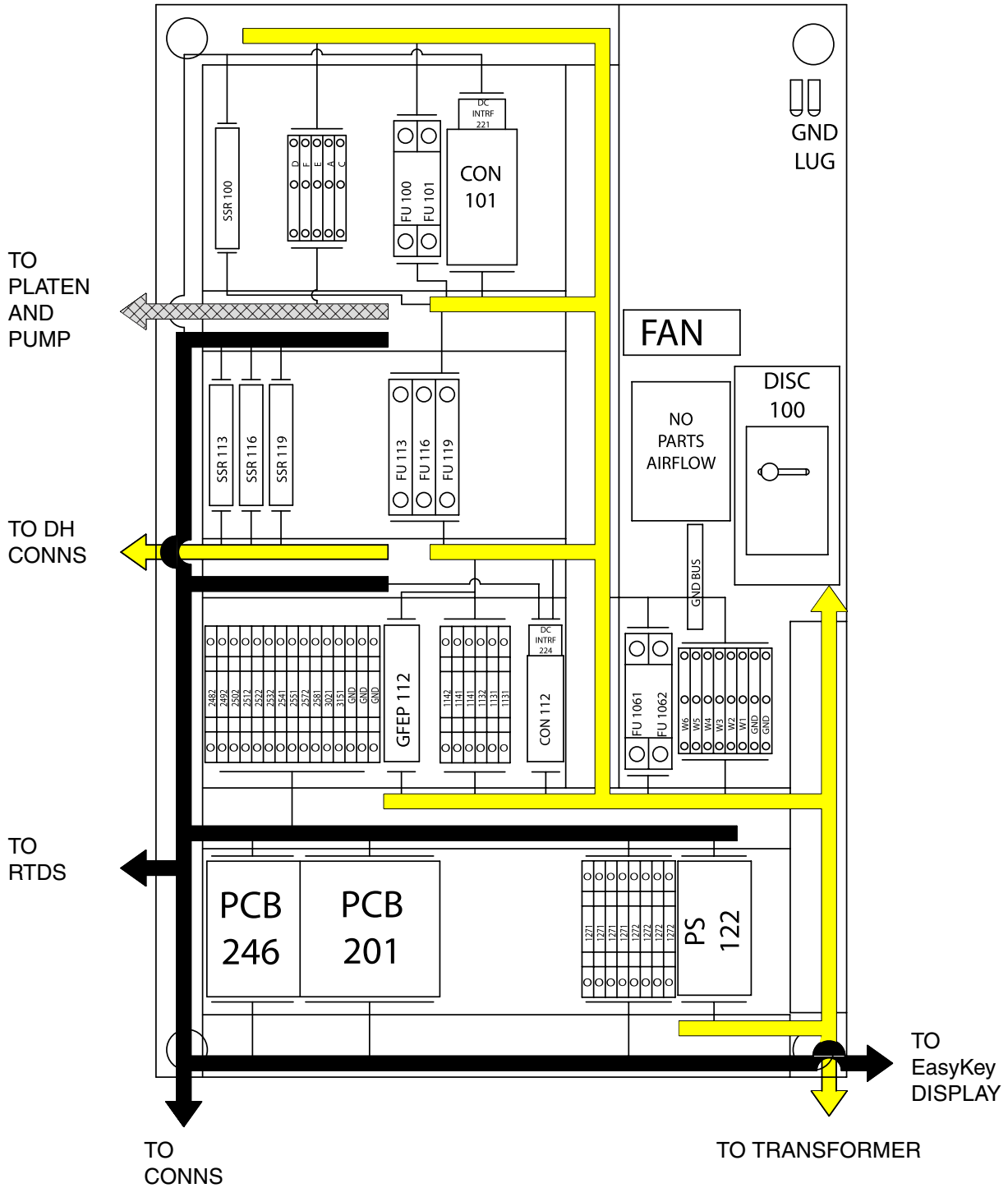

FIG. 25: Light Tower Recommended Wire Routing

## Pail Low and Empty Sensor Kit (255233)

The Pail Low and Empty Sensor Kit is used to indicate that a pail is EMPTY or LOW, depending on the adjustment of the proximity switch. The kit contains a sensor mounting bracket (A), activator (B), sensors (C), and a cable for connecting to the Therm-O-Flow 20 control panel. See FIG. 26.

The low and empty conditions will be displayed in the status bar of the EasyKey display. An optional light tower is also available.

With the optional light tower a yellow light indicates a pail low condition. A flashing yellow light indicates a pail empty condition. In a tandem system a red light indicates both pails are empty. See **Light Tower Kit (253547)**, page 53.

When ordering this kit individually to connect to an existing Therm-O-Flow 20 unloader assembly, use the bolts, screws and washers provided to mount to the closest ram post to the control box. Mount the limit switches to the bracket as shown.

Increasing the distance between the low and empty sensors (C) increases the heat up time for the tandem secondary system. Lowering the pail empty sensor forces the heated platen lower into the pail. If this is set too low the pump could cavitate causing a system alarm.

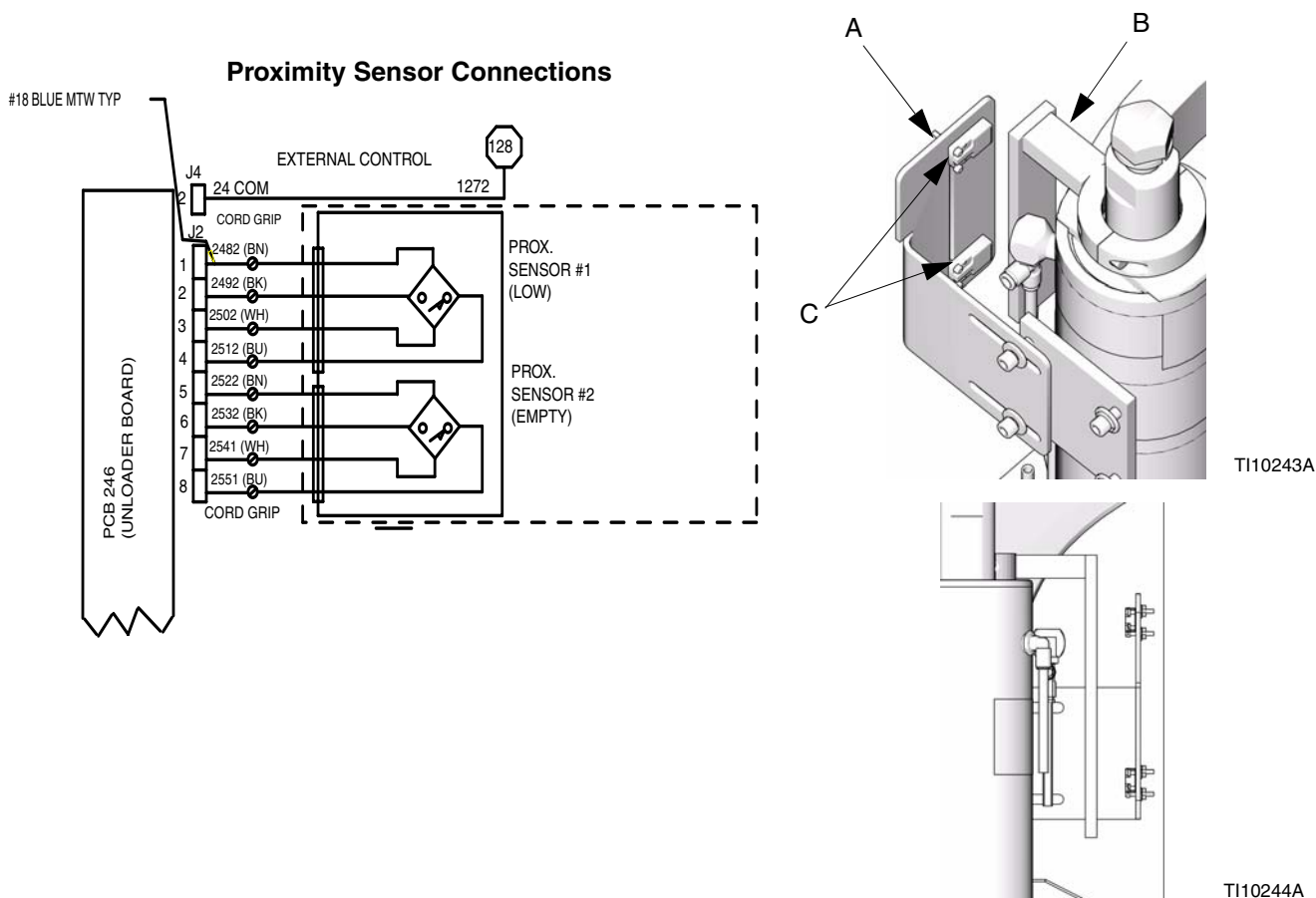

FIG. 26: Optional Low Level Kit

## Ethernet Kit (253566)

This kit is intended for use with the unloaders and accessory box. The Ethernet kit is designed so that the user will have network access to the Therm-O-Flow 20 unit and can clear, display, download, restore, and reset various values from a remote location. This kit includes a Graco Ethernet Expansion Board (15H816), internal Cat 5E patch cord, and the RJ45 panel mount jack.

### Web Interface

**Web Interface** - allows users to connect, view, and change the setup, log, and error files. It does not display run data.

Use the web I/F Software to:

- Install EasyKey Software
- View
  - error log
  - material usage report
  - setup values
- Upload
  - setup values
  - a custom language to view on screen
- Download
  - setup values
  - error log
  - a custom language file
- Clear
  - error log
  - material usage report

- Reset
  - settings to factory default
  - password
- Record
  - temperature and cycle data



If Java Error appears when running the program for the first time, you must download Java RTE (Run Time Environment) for the program to operate correctly. Follow the screen link to Java version 1.4.2.09 or newer. Or enter <http://java.sun.com/j2se/1.4.2/download.html> and select **Download J2SE JRE**. The file is approximately 15 MB.

✓	<b><i>If the Graco program will not start, check the following.</i></b>
	Is the power on?
	Are the cables fully seated in both the PC and Therm-O-Flow 20 ports?
	<ul style="list-style-type: none"> <li>• Are the LEDs on the PC Ethernet connector illuminated?</li> <li>• Are the LEDs on the EasyKey Ethernet mod illuminated? The bottom left LED should be constantly illuminated showing a network connection. The bottom right LED should illuminate when network traffic is occurring. If there are no LEDs illuminated check for loose connections or a loose board.</li> </ul>
	To isolate the problem, try communicating with a different PC.
	Check <b>Local Network Hardware and Software Configuration</b> . See page 58.

There are two possible ways to connect a PC to the unit.

- **Local Network Connection** (most common). Patch cable from the local network plugs into the Web Interface connection. See FIG. 27 and page 58.
- **Direct Connection** to the unit crossover cable from the PC plugs into the Web Interface connection. See FIG. 27 and page 61.



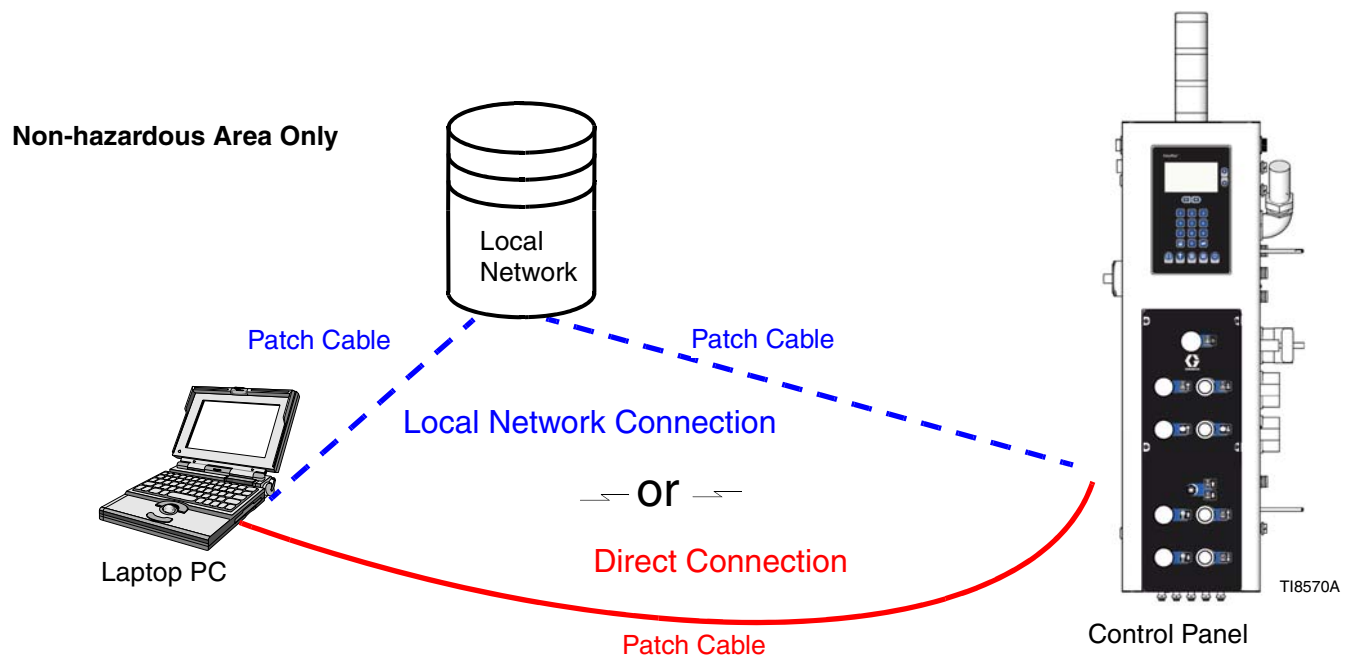
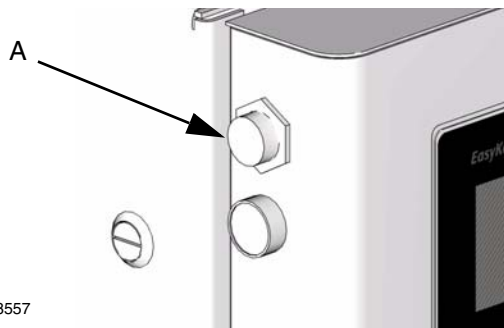

**FIG. 27** Network Selection

## Local Network Hardware and Software Configuration

### Hardware

Patch cables are used to connect each unit to the local network and to the Web connection (A) on the EasyKey panel. See FIG. 28.



ti8557

FIG. 28 EasyKey Web Connection

### Microsoft Browser Configuration

1. Establish a connection/address to the local network.
  - a. Open the PC control panel.
  - b. Select Network Connections.
  - c. Double click on the local area connection.
  - d. Select Properties.
  - e. Select Internet Protocol (TCP/IP).
  - f. Select Properties.
  - g. Select the appropriate Internet connection and key in address 192.168.0.10

2. The EasyKey software requires Sun java to operate. Open your web browser options advanced tab and select Java (Sun) and deselect the Microsoft VM selection. See FIG. 29. If the Sun Java option is not available follow the **Software Operation** procedure and load the Sun Java program when the appropriate screen and link appear.



Browser must be closed and restarted for change to be effective.

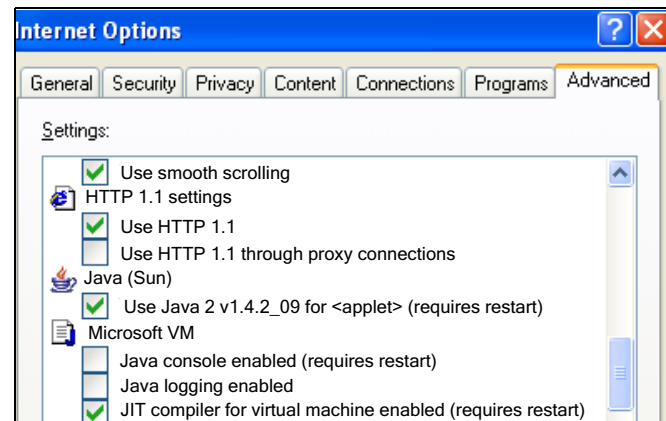

FIG. 29 Java Internet Options



It may be necessary to change the Java selection from Sun to Microsoft for other software applications to run correctly on your PC.

If you cannot make these changes contact your I.S. department and request they change your computer access rights. **You must have administrative rights to change the settings.**

## Software Operation

1. Open Microsoft Internet Explorer.
2. In the address area type http://192.168.0.1
3. Click Enter.
4. Select yes when security screen appears.
5. Main software screen appears. See FIG. 30.
  - If “Cannot Read Firmware” appears check for loose hardware connections.
  - If “Java script needs to be loaded” appears follow the screen link to install this freeware.

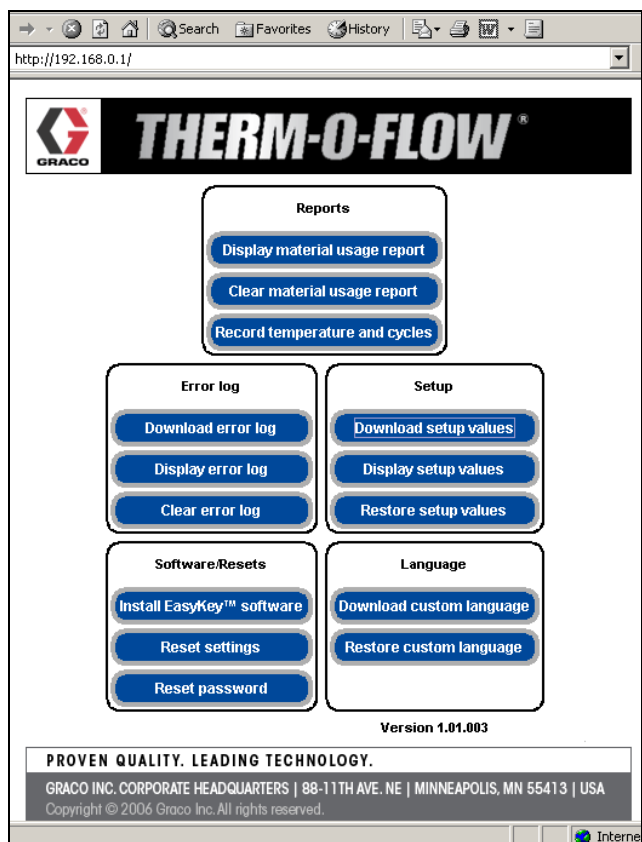

FIG. 30: Main Software Screen

## Web Navigation Screens

From the main screen (see FIG. 30) the operator can select buttons for reports, error log, setup, software/resets, or language.

## Reports

**Display material usage report** - shows the material pumped from the unit. See FIG. 31.

Data for Display material usage report		
Material Usage		
Start Time:	03-08-2007	20:08:23
Cycle Count	0	
Grand Total	0	

FIG. 31: Display Material Usage Report

**Clear material usage report** - deletes the material usage from the system run screen batch total. Does not reset grand total in setup.

**Record Temperature and Cycles** - records temperature and cycle information once per minute. A file is opened and data recorded. See FIG. 32.

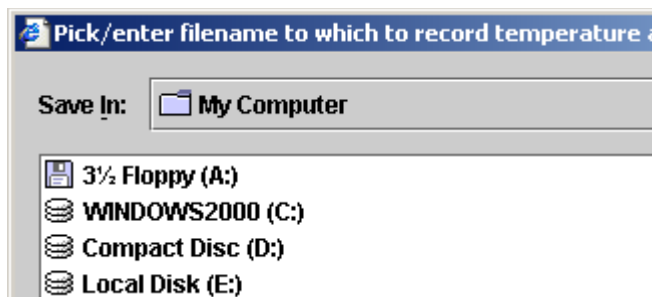

FIG. 32

While data is recorded other web functions are unavailable. See FIG. 33.

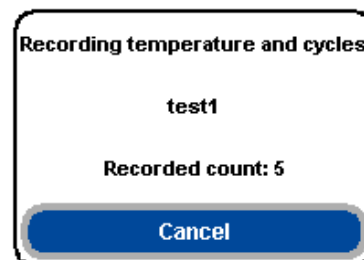
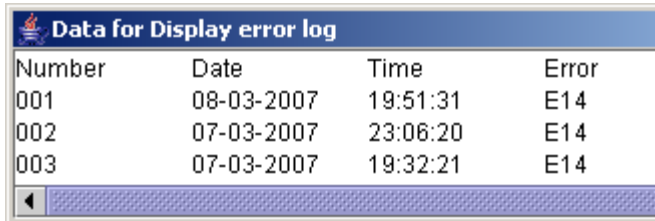

FIG. 33

## Error Log

**Download error log** - downloads the error log to the PC.

**Display error log** - displays the number of alarms, date, time, recipe and what the error was. See FIG. 34.



Number	Date	Time	Error
001	08-03-2007	19:51:31	E14
002	07-03-2007	23:06:20	E14
003	07-03-2007	19:32:21	E14

FIG. 34: Display Error Log

**Clear error log** - deletes the errors from the display.

## Setup

**Download setup values** - saves the TOF configuration to the PC. This file can be opened and edited using Microsoft Excel, or used to set up multiple systems.

**Display setup values** - indicates what values are currently being used for the system. Allows the operator to verify that the right values are being used. See FIG. 35.

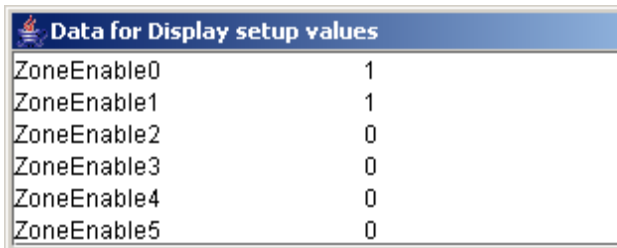

ZoneEnable0	ZoneEnable1	ZoneEnable2	ZoneEnable3	ZoneEnable4	ZoneEnable5
1	1	0	0	0	0

FIG. 35: Display Setup

**Restore setup values** - allows files to be uploaded and restored to the TOF.

## Software/Resets

**Install EasyKey software** - downloads the Graco provided software to the PC (approximately 5 minutes). Once complete the control panel will be reprogrammed from the EasyKey.

**Reset settings** - places system back to factory default mode.

**Reset password** - clears password if lost or forgotten.

## Language

**Download custom Language** - saves the current system language to the PC. This file is opened and a custom language added to the B column of the Excel file. See FIG. 36.



Custom languages are limited to Ascii and Ascii extended characters and a maximum of 32 characters. Save the Excel file as a tab delineated file for uploading purposes.

**Restore custom language** - allows the custom language file to be uploaded to the TOF.

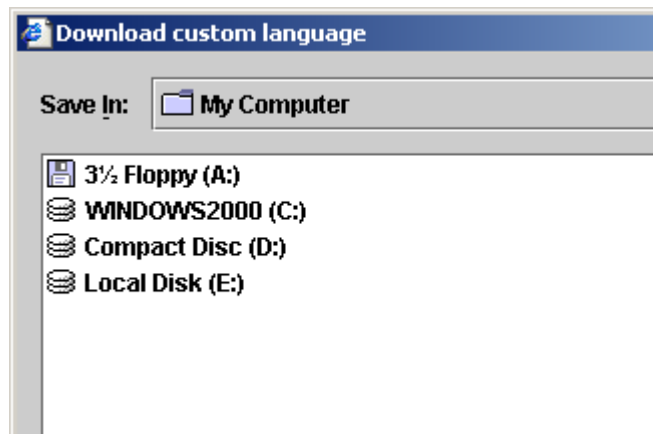





FIG. 36: Download Custom Language

## Advanced Configuration

To change IP settings use the freeware configuration program available from [www.lantronix.com/device-net-working/utilities-tools/device-installer.html](http://www.lantronix.com/device-net-working/utilities-tools/device-installer.html).

## Ethernet Kit Installation

Graco Kit 253566 is required for this connection.

						
Do not operate Therm-O-Flow 20 with equipment enclosure doors/covers open. Disconnect power source before servicing or electrically wiring.						

1. Power the Therm-O-Flow system off and disconnect power source.
2. Open the control panel door.
3. Remove the EasyKey Display shield.
4. Locate the 10 pin Expansion Connector J9 (A) on the lower right of the EasyKey Display Assembly 249480 (B). See FIG. 38.
5. Plug the Ethernet Assembly 249183 (C) into J9 making sure the RJ45 connector is oriented down. See FIG. 39 and FIG. 40.
6. Secure the Ethernet Assembly 249183 (C) to the EasyKey Display 249480 (B) using the hardware provided.
7. Remove plug (D) covering Ethernet opening at the upper right corner of the Control Panel. See FIG. 37.
8. Secure Bulkhead Receptacle in the Ethernet opening at the upper right corner of the Control Panel.
9. Connect one end of the Ethernet cable to Ethernet Assembly 249183 (C).
10. Replace EasyKey Display shield connecting ground terminal from Ethernet Bulkhead connector to upper right stud.
11. Connect the other end of the Ethernet cable to the Ethernet bulkhead receptacle.
12. Close the Control Panel door.

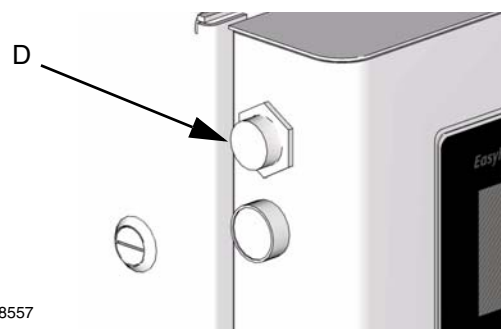

**FIG. 37: RJ45 Bulkhead Connector Installation**

## Changing Network Configuration

1. Connect PC to Ethernet connection on EasyKey with the crossover cable.
2. Connect network to PC with DeviceInstaller.
3. Run DeviceInstaller program.



A freeware configuration program is available from [www.lantronix.com/device-networking/utilities-tools/device-installer.html](http://www.lantronix.com/device-networking/utilities-tools/device-installer.html)

4. To change IP Address from Default setting 192.168.0.1
  - a. Run DeviceInstaller
  - b. Click "Search"
  - c. Select device
  - d. Click "Assign IP"

Select and assign specific IP address.

  - i. Input address
  - ii. Enter subnet mask 255.255.255.0
  - iii. Click "Assign" (unit is programmed and will now reboot)
  - iv. Click "Finish"
  - v. Close/Exit DeviceInstaller



Alternate method via telnet and port 9999.

## Serial Port Setup



Kit is pre-programmed with these settings:  
57,600 baud, 8-bit, no parity, 1-stop bit.

# EasyKey Modbus / TCP Wiring Diagram

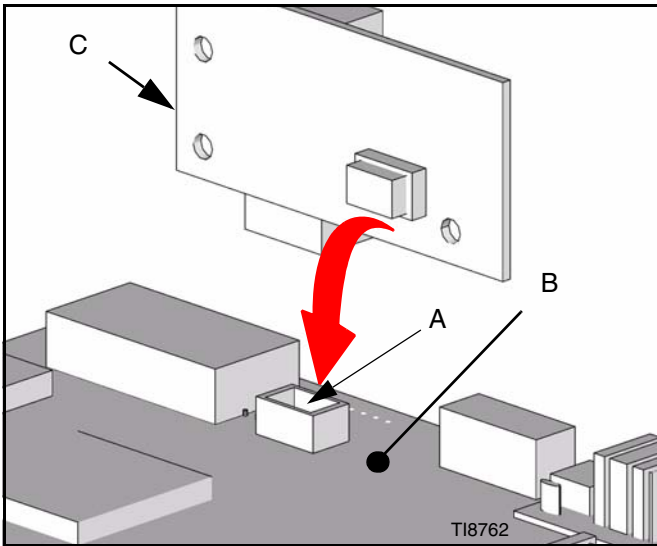

FIG. 38

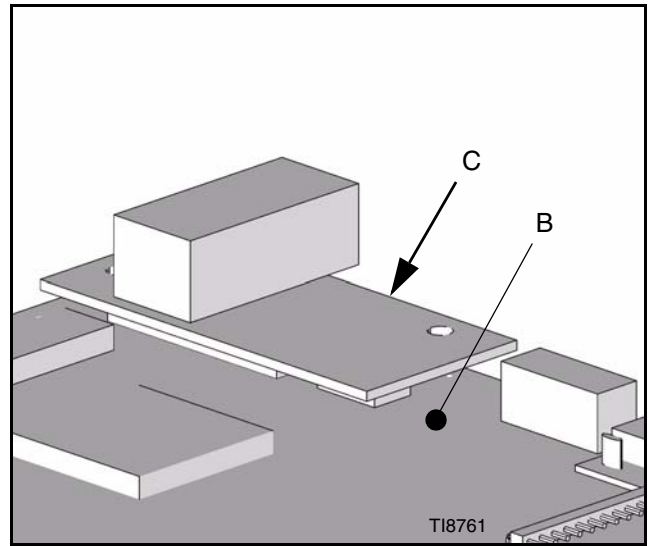

FIG. 39

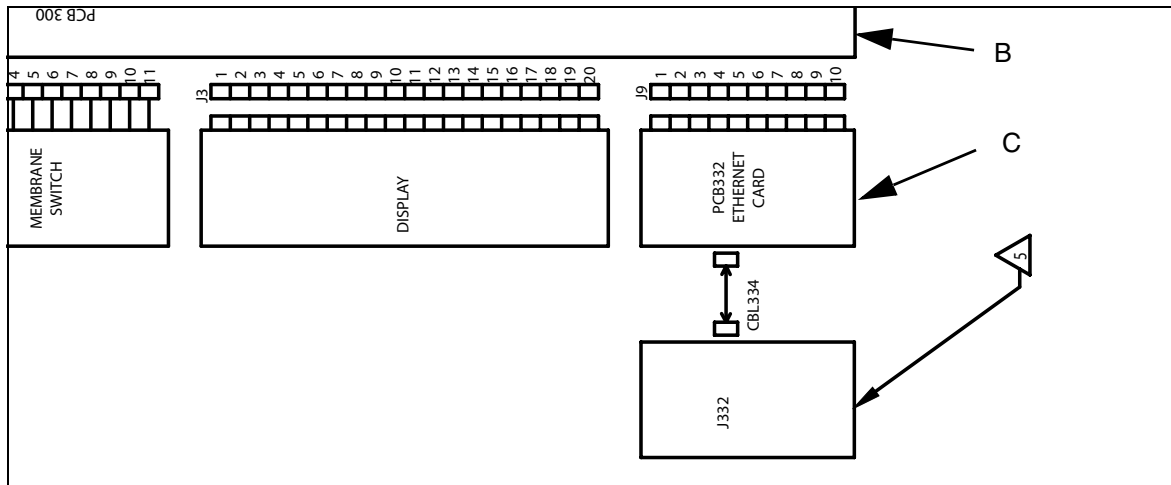

FIG. 40

## Maintenance Call Kit (253548)

The maintenance call kit is designed for the user to indicate an issue has occurred and needs to be addressed, but the unit keeps operating if no serious faults have occurred. With the optional light tower kit the maintenance call button (E) causes the yellow light to flash making the problem more obvious. See FIG. 41. This kit includes the pushbutton actuator and internal harness to connect the button. For additional light tower information see **Light Tower Kit (253547)** on page 53.



TI8557A

**FIG. 41: Maintenance Call Kit**

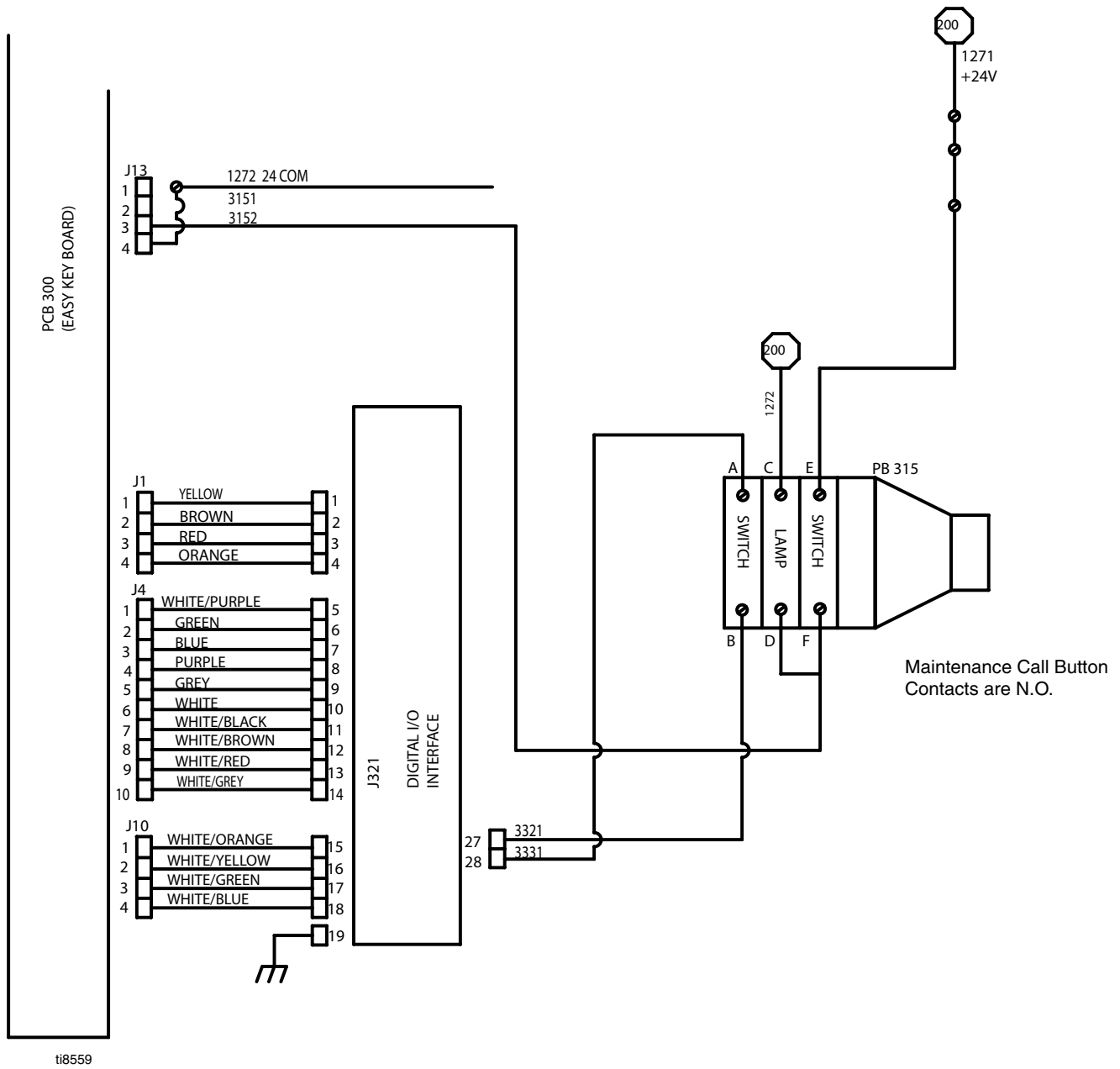

FIG. 42: Maintenance Call Kit Wiring



## Discrete I/O Kit (253567)

The discrete I/O kit is designed to connect to robots or PLC that control the primary unit. This connection allows the communication of System On/Off, Heat On/Heat Soak/Ready, Setback, Pail Empty, Warnings, Alarms, Maintenance, and Gun switch. Included in this kit is the Internal Cable Harness to convert the primary unit and the 40 ft external cable, which has individual wire on the robot/PLC end for the user to install.



TI8558A

Fig. 43: Discrete I/O Kit

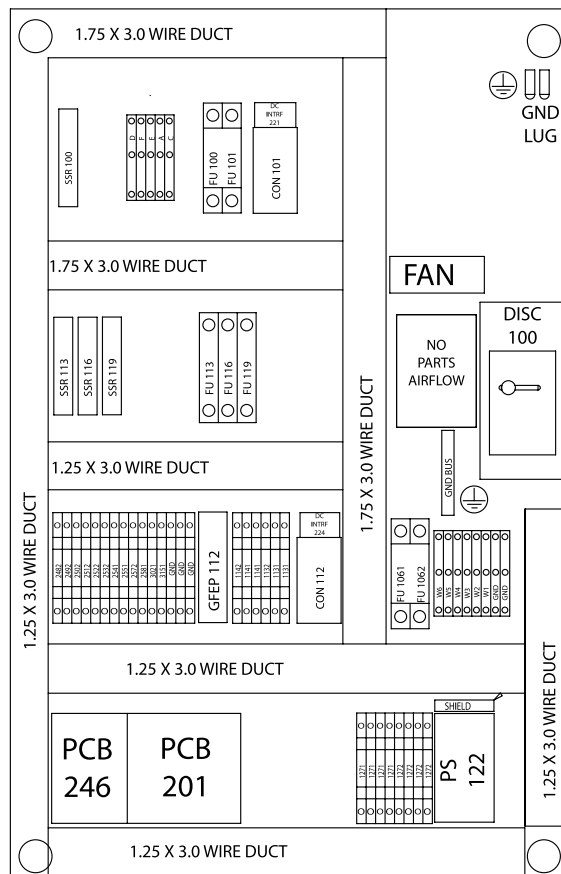
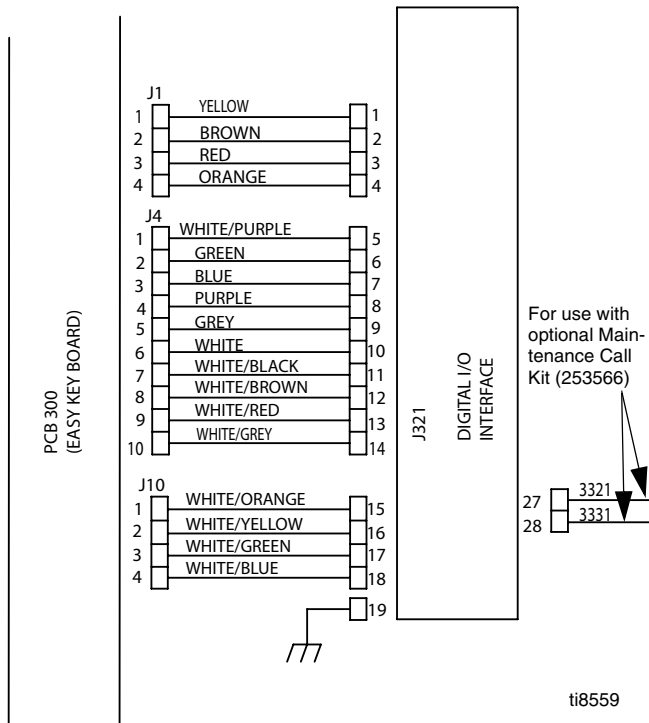

Fig. 44



**FIG. 45: Discrete I/O Kit Wiring**

Pin No.	Signal Description	Signal Type	Wire Color
1	Digital Input Reference	Digital Input Ref	Yellow
2	System On/Off	Digital Input	Brown
3	Heat On/Off	Digital Input	Red
4	Pump On/Off	Digital Input	Orange
5	24 Vdc from Robot/PLC	Digital Input Ref	Tan
6	System On/Off	Digital Output	Green
7	System Run	Digital Output	Blue
8	Heat On/Heat Soak Ready	Digital Output	Violet
9	Setback	Digital Output	Gray
10	Drum Empty	Digital Output	White
11	Warning	Digital Output	White/Black
12	Alarm	Digital Output	Pink
13	Maintenance	Digital Output	White/Red
14	24 Vdc from Robot/PLC	Digital Input Ref	Red/Green
15	Analog Gnd Ref	Analog Gnd Ref	Red/Yellow
16		Analog Input	White/Yellow
17	Analog Gnd Ref	Analog Gnd Ref	White/Green
18		Analog Output	White/Blue
19	Ground	Shield Connection	
27	Maintenance Call Button	Digital Output	Black
28	Maintenance Call Button	Digital Input Ref	Red/Black

# Swirl Kit, Part No. 253263

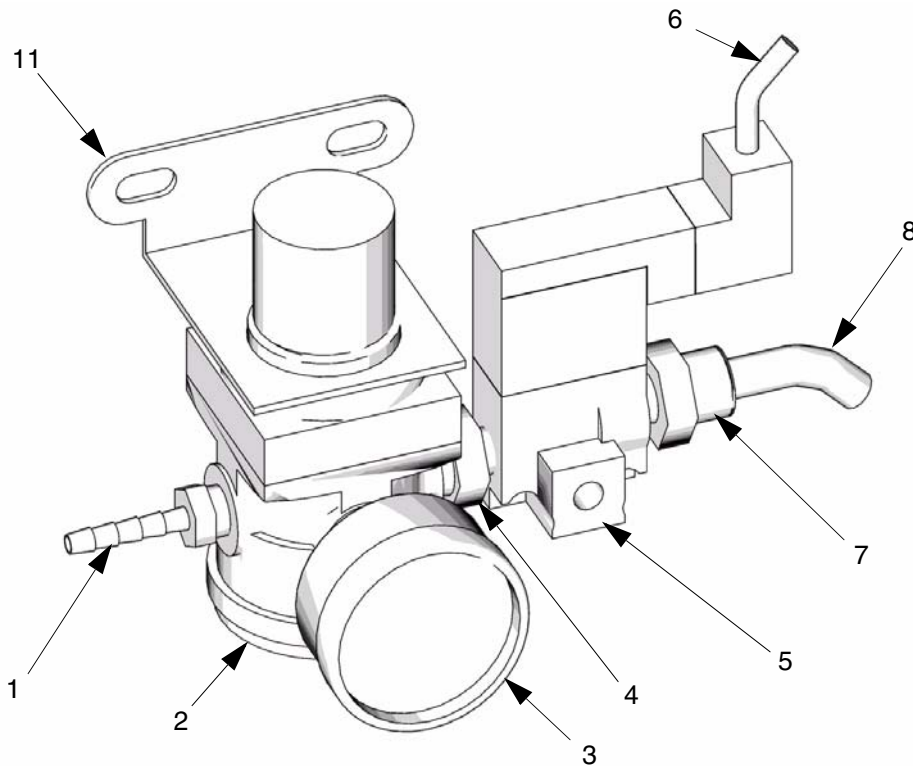

T17921A

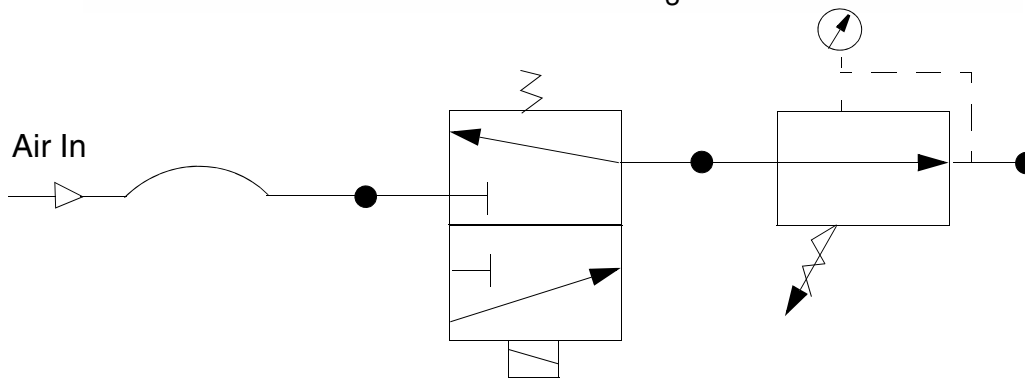

Ref. No.	Part No.	Description	Qty.	Ref. No.	Part No.	Description	Qty.
1		.125 ID hose barb x 1/4 NPT Male brass fitting	1	7		Tube Fitting	1
2		Regulator	1	8		Nylon tube	3 ft.
3		Gauge	1	9		Socket head cap screw (not shown)	2
4		1/4 to 1/8 Brass Hex Nipple	1	10		Tube Clamp (not shown)	1
5		Solenoid Valve	1	11		Regulator mounting bracket	1
6	120384	Cable	1				

# Dimensions

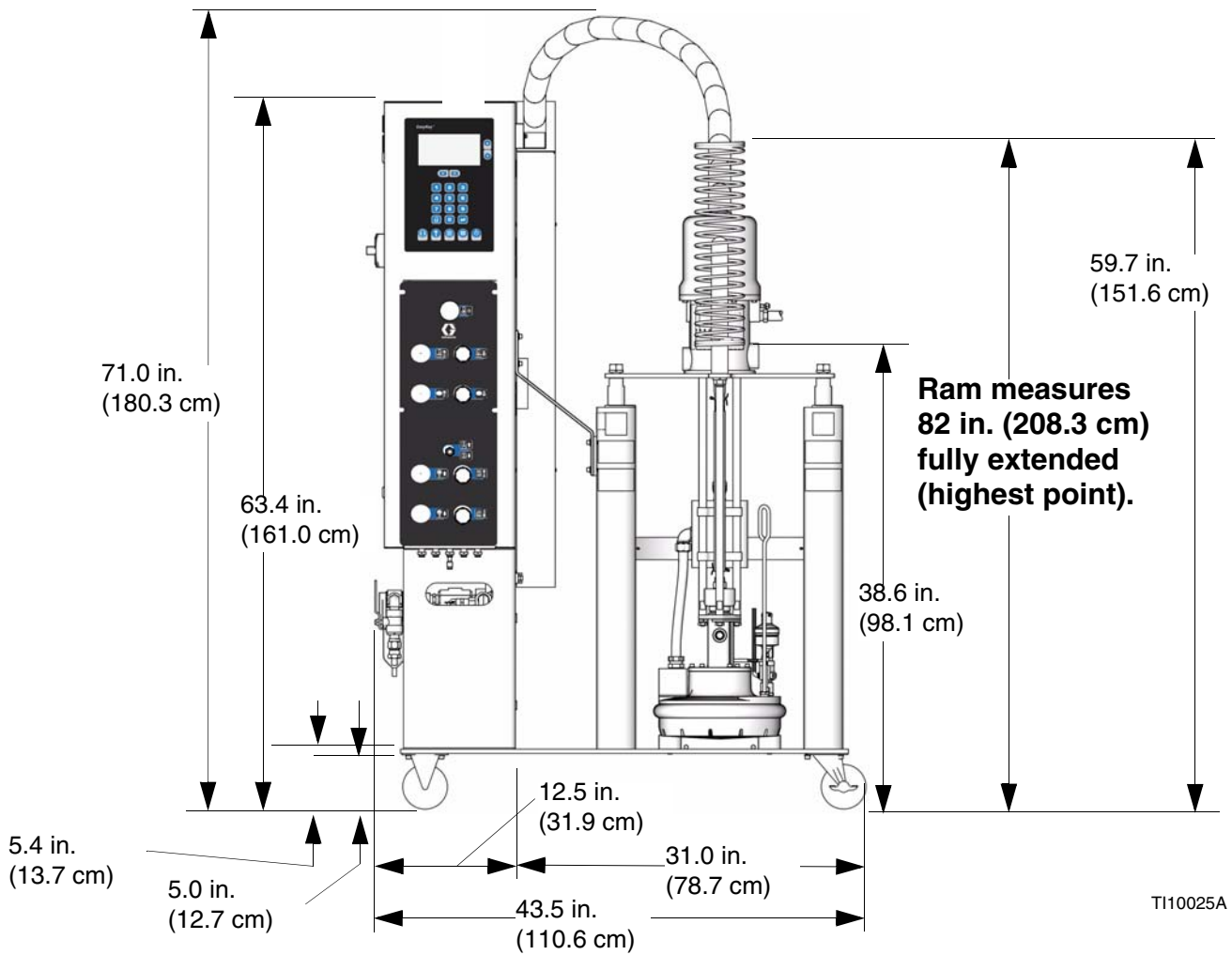
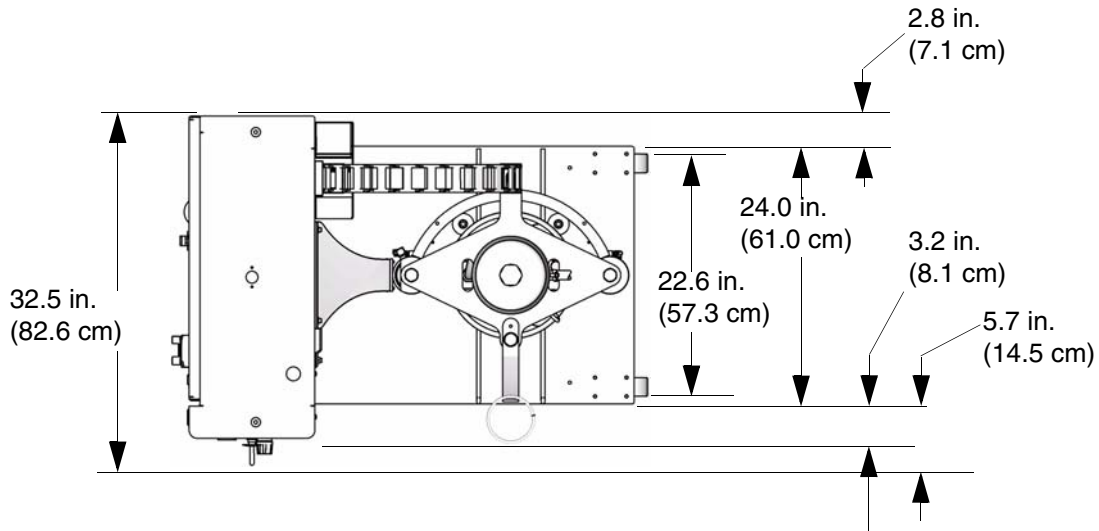

# Technical Data

Displacement pump effective area . . . . .	1.24 in. <sup>2</sup> (8 cm <sup>2</sup> )
Volume per cycle . . . . .	11.7 in. <sup>3</sup> (192 cm <sup>3</sup> )
Pump cycles per 1 gal. (3.8 liters) . . . . .	21
Maximum fluid working pressure . . . . .	1800 psi (12.6 MPa, 126 bar)
Maximum air input pressure . . . . .	120 psi (0.8 MPa, 8.4 bar)
Maximum pump operating temperature . . . . .	400°F (204°C)
Air motor piston effective area . . . . .	
Air inlet size . . . . .	1/2 npsm(f)
Pump fluid outlet size . . . . .	1 in. npt(f)
Wetted parts . . . . .	Carbon steel; brass; chrome, zinc, and nickel plating; 304, 316, 440, and 17-4 PH grades of stainless steel; alloy steel; ductile iron; PTFE
Weight . . . . .	670 lb (304 kg)
Instruction Manuals	
Heated Hoses . . . . .	309160
Wiper Kits . . . . .	309196
3.5 in. (88.9 mm) Global Ram Module . . . . .	New
Power requirements	
Compressed air . . . . .	25-50 scfm (typical)
Voltage (as selected) . . . . .	220/240 V, 3-phase, 50/60 Hz
	380/400 V, 3-phase, 50/60 Hz
	470/490 V, 3-phase, 50/60 Hz
Peak consumption*	
with standard melt grid . . . . .	6.4 kVa

\* Includes pail melt grid, pump, and a 5 kVa transformer for the 230 V hoses and accessories.

# Graco Standard Warranty

Graco warrants all equipment referenced in this document which is manufactured by Graco and bearing its name to be free from defects in material and workmanship on the date of sale to the original purchaser for use. With the exception of any special, extended, or limited warranty published by Graco, Graco will, for a period of twelve months from the date of sale, repair or replace any part of the equipment determined by Graco to be defective. This warranty applies only when the equipment is installed, operated and maintained in accordance with Graco's written recommendations.

This warranty does not cover, and Graco shall not be liable for general wear and tear, or any malfunction, damage or wear caused by faulty installation, misapplication, abrasion, corrosion, inadequate or improper maintenance, negligence, accident, tampering, or substitution of non-Graco component parts. Nor shall Graco be liable for malfunction, damage or wear caused by the incompatibility of Graco equipment with structures, accessories, equipment or materials not supplied by Graco, or the improper design, manufacture, installation, operation or maintenance of structures, accessories, equipment or materials not supplied by Graco.

This warranty is conditioned upon the prepaid return of the equipment claimed to be defective to an authorized Graco distributor for verification of the claimed defect. If the claimed defect is verified, Graco will repair or replace free of charge any defective parts. The equipment will be returned to the original purchaser transportation prepaid. If inspection of the equipment does not disclose any defect in material or workmanship, repairs will be made at a reasonable charge, which charges may include the costs of parts, labor, and transportation.

**THIS WARRANTY IS EXCLUSIVE, AND IS IN LIEU OF ANY OTHER WARRANTIES, EXPRESS OR IMPLIED, INCLUDING BUT NOT LIMITED TO WARRANTY OF MERCHANTABILITY OR WARRANTY OF FITNESS FOR A PARTICULAR PURPOSE.**

Graco's sole obligation and buyer's sole remedy for any breach of warranty shall be as set forth above. The buyer agrees that no other remedy (including, but not limited to, incidental or consequential damages for lost profits, lost sales, injury to person or property, or any other incidental or consequential loss) shall be available. Any action for breach of warranty must be brought within two (2) years of the date of sale.

**GRACO MAKES NO WARRANTY, AND DISCLAIMS ALL IMPLIED WARRANTIES OF MERCHANTABILITY AND FITNESS FOR A PARTICULAR PURPOSE, IN CONNECTION WITH ACCESSORIES, EQUIPMENT, MATERIALS OR COMPONENTS SOLD BUT NOT MANUFACTURED BY GRACO.** These items sold, but not manufactured by Graco (such as electric motors, switches, hose, etc.), are subject to the warranty, if any, of their manufacturer. Graco will provide purchaser with reasonable assistance in making any claim for breach of these warranties.

In no event will Graco be liable for indirect, incidental, special or consequential damages resulting from Graco supplying equipment hereunder, or the furnishing, performance, or use of any products or other goods sold hereto, whether due to a breach of contract, breach of warranty, the negligence of Graco, or otherwise.

## **FOR GRACO CANADA CUSTOMERS**

The parties acknowledge that they have required that the present document, as well as all documents, notices and legal proceedings entered into, given or instituted pursuant hereto or relating directly or indirectly hereto, be drawn up in English. Les parties reconnaissent avoir convenu que la rédaction du présente document sera en Anglais, ainsi que tous documents, avis et procédures judiciaires exécutés, donnés ou intentés à la suite de ou en rapport, directement ou indirectement, avec les procédures concernées.

# Graco Information

**TO PLACE AN ORDER**, contact your Graco distributor, or call this number to identify the distributor closest to you:

**1-800-328-0211 Toll Free**

**612-623-6921**

**612-378-3505 Fax**

*All written and visual data contained in this document reflects the latest product information available at the time of publication.  
Graco reserves the right to make changes at any time without notice.*

MM 312094

**Graco Headquarters:** Minneapolis

**International Offices:** Belgium, China, Japan, Korea

**GRACO INC. P.O. BOX 1441 MINNEAPOLIS, MN 55440-1441**

[www.graco.com](http://www.graco.com)

4/2007