

MAGNUM™

by GRACO®

Magnum Plus A20, Pro Plus A20, Pro Plus A30, Pro 332655C Plus A45, and Pro Plus A60 Airless Sprayer

EN

- For portable spray applications of architectural paints and coatings -

Models 16W108, 16E664, 16E665, 16W515, 17C243, 17C244, 17C245, 17C246



IMPORTANT SAFETY INSTRUCTIONS

Read all warnings and instructions in this manual.
Save these instructions.

See page 3 for model series information including dispense rate, recommended hose length, guns, and maximum working pressure.

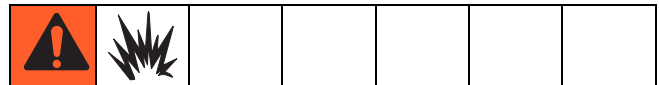

A20, A30, A45 ONLY: Use water-based or mineral spirit-type materials only. Do not use materials having flash points lower than 100° F (38° C). This includes, but is not limited to, acetone, xylene, toluene, or naphtha. For more information about your material, request MSDS from distributor or retailer.

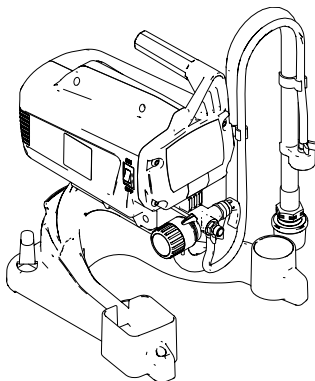

Pro Plus A20
Model: 16W108
Series A
Plus A20
Model: 17C243
Series A

ti22045a

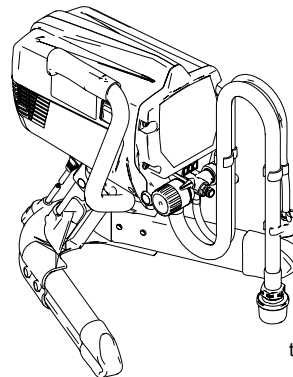

Pro Plus A30
Model: 16E664
Series B
Model: 17C244
Series A

ti22084a

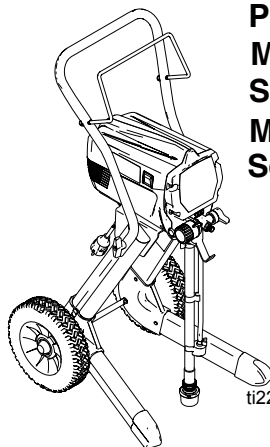

Pro Plus A45
Model: 16E665
Series B
Model: 17C245
Series A

ti22085a

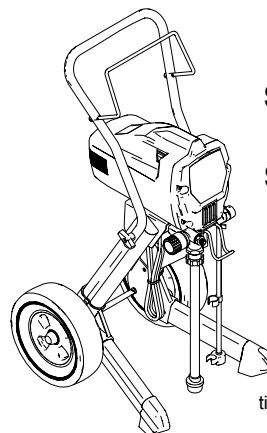

Pro Plus A60
Model: 16W515
Series A
Model: 17C246
Series A

ti22143a



Table of Contents

| | |
|--|-----------|
| Specifications | 3 |
| Warnings | 4 |
| Component Identification A20 and A30 | 8 |
| Component Identification A45 and A60 | 10 |
| Grounding and Electric Requirements | 12 |
| Thermal Overload | 12 |
| Operation | 13 |
| Trigger Lock | 13 |
| Pressure Relief Procedure | 13 |
| Pressure Control Knob Settings | 13 |
| Setup | 14 |
| Prime and Flush Storage Fluid | 14 |
| Install Tip and Guard on Gun | 16 |
| Spraying Techniques | 17 |
| Getting Started | 17 |
| Triggering Gun | 17 |
| Aiming Gun | 17 |
| Unclogging Spray Tip | 18 |
| Tip Selection | 18 |
| Choosing the Correct Tip | 19 |
| Reversible Tip Selection Chart | 19 |
| Shutdown and Cleaning | 20 |
| Pail Flushing | 20 |
| Power Flush | 22 |
| Cleaning InstaClean™ Fluid Filter (A60 Only) | 24 |
| Cleaning Gun | 24 |
| Storage | 25 |
| Short Term Storage | 25 |
| Long Term Storage | 25 |
| Stowing Sprayer 26 | |
| Maintenance and Service | 27 |
| Caring for Sprayer | 27 |
| Paint Hoses | 27 |
| Tips | 27 |
| Pump Check Valves | 27 |
| Pump Packings | 27 |
| Troubleshooting | 28 |
| Technical Data | 33 |
| Notes | 35 |
| Graco Standard Warranty | 36 |

Specifications

This equipment is not intended for use with flammable or combustible materials used in places such as cabinet shops or other “factory”, or fixed locations. If you intend to use this equipment in this type of application, you must comply with NFPA 33 and OSHA requirements for the use of flammable and combustible materials.

| Model Name | Series | Maximum Dispense Rate gpm (lpm) | Hose Length and Diameter | Gun Model | Maximum Working Pressure | | |
|------------|--------|---------------------------------|-------------------------------------|-----------|--------------------------|-----|------|
| | | | | | bar | MPa | PSI |
| A20 | A | 0.91 lpm (0.24 gpm) | 6.4 mm x 7.5 m (1/4 in. x 25 ft) | SG2 | 207 | 21 | 3000 |
| A30 | A, B | 1.02 lpm (0.27 gpm) | 6.4 mm x 7.5 m (1/4 in. x 25 ft) | SG3 | 207 | 21 | 3000 |
| A45 | A, B | 1.17 lpm (0.31 gpm) | 6.4 mm x 15 m (1/4 in. X 50 ft) | SG3 | 207 | 21 | 3000 |
| A60 | A | 1.44 lpm (0.38 gpm) | 6.4 mm x 15 m (1/4 in. X 50 ft) | SG3 | 207 | 21 | 3000 |

Warnings

The following warnings are for the setup, use, grounding, maintenance, and repair of this equipment. The exclamation point symbol alerts you to a general warning and the hazard symbols refer to procedure-specific risks. When these symbols appear in the body of this manual or on warning labels, refer back to these Warnings. Product-specific hazard symbols and warnings not covered in this section may appear throughout the body of this manual where applicable.

WARNING



GROUNDING

This product must be grounded. In the event of an electrical short circuit, grounding reduces the risk of electric shock by providing an escape wire for the electric current. This product is equipped with a cord having a grounding wire with an appropriate grounding plug. The plug must be plugged into an outlet that is properly installed and grounded in accordance with all local codes and ordinances.

- Improper installation of the grounding plug is able to result in a risk of electric shock.
- When repair or replacement of the cord or plug is required, do not connect the grounding wire to either flat blade terminal.
- The wire with insulation having an outer surface that is green with or without yellow stripes is the grounding wire.
- Check with a qualified electrician or serviceman when the grounding instructions are not completely understood, or when in doubt as to whether the product is properly grounded.
- Do not modify the plug provided; if it does not fit the outlet, have the proper outlet installed by a qualified electrician.
- This product is for use on a nominal 230V circuit and has a grounding plug similar to the plug illustrated in the figure below.

230V

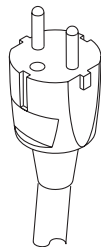

- Only connect the product to an outlet having the same configuration as the plug.
- Do not use an adapter with this product.

Extension Cords:

- Use only an extension cord that has a grounding plug and a receptacle that accepts the plug on the product.
- Make sure your extension cord is not damaged. If an extension cord is necessary, use 12 AWG (2.5 mm²) minimum to carry the current that the product draws.
- An undersized cord results in a drop in line voltage and loss of power and overheating.

WARNING



FIRE AND EXPLOSION HAZARD

Flammable fumes, such as solvent and paint fumes, in work area can ignite or explode. To help prevent fire and explosion:

- Do not spray flammable or combustible materials near an open flame or sources of ignition such as cigarettes, motors, and electrical equipment. **For A20, A30, and A45 models:** only use water-based or mineral spirit-type materials with a flash point greater than 100° F (38° C).
- Do not spray combustible materials near an open flame or sources of ignition such as cigarettes, motors, and electrical equipment.
- Paint or solvent flowing through the equipment is able to result in static electricity. Static electricity creates a risk of fire or explosion in the presence of paint or solvent fumes. All parts of the spray system, including the pump, hose assembly, spray gun, and objects in and around the spray area shall be properly grounded to protect against static discharge and sparks. Use Graco conductive or grounded high-pressure airless paint sprayer hoses.
- Verify that all containers and collection systems are grounded to prevent static discharge. Do not use pail liners unless they are antistatic or conductive.
- Connect to a grounded outlet and use grounded extensions cords. Do not use a 3-to-2 adapter.
- Do not use a paint or a solvent containing halogenated hydrocarbons.
- Keep spray area well-ventilated. Keep a good supply of fresh air moving through the area. Keep pump assembly in a well ventilated area. Do not spray pump assembly.
- Do not smoke in the spray area.
- Do not operate light switches, engines, or similar spark producing products in the spray area.
- Keep area clean and free of paint or solvent containers, rags, and other flammable materials.
- Know the contents of the paints and solvents being sprayed. Read all Material Safety Data Sheets (MSDS) and container labels provided with the paints and solvents. Follow the paint and solvents manufacturer's safety instructions.
- Fire extinguisher equipment shall be present and working.
- Sprayer generates sparks. When combustible materials are used in or near the sprayer or for flushing or cleaning, keep sprayer at least 20 feet (6 m) away from explosive vapors.

WARNING



SKIN INJECTION HAZARD

High-pressure spray is able to inject toxins into the body and cause serious bodily injury. In the event that injection occurs, **get immediate surgical treatment.**

- Do not aim the gun at, or spray any person or animal.
- Keep hands and other body parts away from the discharge. For example, do not try to stop leaks with any part of the body.
- Always use the nozzle tip guard. Do not spray without nozzle tip guard in place.
- Use Graco nozzle tips.
- Use caution when cleaning and changing nozzle tips. In the case where the nozzle tip clogs while spraying, follow the **Pressure Relief Procedure** for turning off the unit and relieving the pressure before removing the nozzle tip to clean.
- Do not leave the unit energized or under pressure while unattended. When the unit is not in use, turn off the unit and follow the **Pressure Relief Procedure** for turning off the unit.
- Check hoses and parts for signs of damage. Replace any damaged hoses or parts.
- This system is capable of producing 3000 psi. Use Graco replacement parts or accessories that are rated a minimum of 3000 psi.
- Always engage the trigger lock when not spraying. Verify the trigger lock is functioning properly.
- Verify that all connections are secure before operating the unit.
- Know how to stop the unit and bleed pressure quickly. Be thoroughly familiar with the controls.









EQUIPMENT MISUSE HAZARD

Misuse can cause death or serious injury.

- Do not operate the unit when fatigued or under the influence of drugs or alcohol.
- Do not exceed the maximum working pressure or temperature rating of the lowest rated system component. See **Technical Data** in all equipment manuals.
- Use fluids and solvents that are compatible with equipment wetted parts. See Technical Data in all equipment manuals. Read fluid and solvent manufacturer's warnings. For complete information about your material, request MSDS from distributor or retailer.
- Do not leave the work area while equipment is energized or under pressure.
- Turn off all equipment and follow the **Pressure Relief Procedure** when equipment is not in use.
- Check equipment daily. Repair or replace worn or damaged parts immediately with genuine manufacturer's replacement parts only.
- Do not alter or modify equipment. Alterations or modifications may void agency approvals and create safety hazards.
- Make sure all equipment is rated and approved for the environment in which you are using it.
- Use equipment only for its intended purpose. Call your distributor for information.
- Route hoses and cables away from traffic areas, sharp edges, moving parts, and hot surfaces.
- Do not kink or over bend hoses or use hoses to pull equipment.
- Keep children and animals away from work area.
- Comply with all applicable safety regulations.

! WARNING

| | |
|--|--|
|  | <p>ELECTRIC SHOCK HAZARD</p> <p>This equipment must be grounded. Improper grounding, setup, or usage of the system can cause electric shock.</p> <ul style="list-style-type: none"> • Turn off and disconnect power cord before servicing equipment. • Connect only to grounded electrical outlets. • Use only 3-wire extension cords. • Ensure ground prongs are intact on power and extension cords. • Do not expose to rain. Store indoors. |
|  | <p>PRESSURIZED ALUMINUM PARTS HAZARD</p> <p>Use of fluids that are incompatible with aluminum in pressurized equipment can cause serious chemical reaction and equipment rupture. Failure to follow this warning can result in death, serious injury, or property damage.</p> <ul style="list-style-type: none"> • Do not use 1,1,1-trichloroethane, methylene chloride, other halogenated hydrocarbon solvents or fluids containing such solvents. • Many other fluids may contain chemicals that can react with aluminum. Contact your material supplier for compatibility. |
|  | <p>BURN HAZARD</p> <p>Equipment surfaces and fluid that is heated can become very hot during operation. To avoid severe burns:</p> <ul style="list-style-type: none"> • Do not touch hot fluid or equipment. |
|   | <p>MOVING PARTS HAZARD</p> <p>Moving parts can pinch, cut or amputate fingers and other body parts.</p> <ul style="list-style-type: none"> • Keep clear of moving parts. • Do not operate equipment with protective guards or covers removed. • Pressurized equipment can start without warning. Before checking, moving, or servicing equipment, follow the Pressure Relief Procedure and disconnect all power sources. |
|  | <p>TOXIC FLUID OR FUMES HAZARD</p> <p>Toxic fluids or fumes can cause serious injury or death if splashed in the eyes or on skin, inhaled, or swallowed.</p> <ul style="list-style-type: none"> • Read MSDSs to know the specific hazards of the fluids you are using. • Store hazardous fluid in approved containers, and dispose of it according to applicable guidelines. |
|  | <p>PERSONAL PROTECTIVE EQUIPMENT</p> <p>Wear appropriate protective equipment when in the work area to help prevent serious injury, including eye injury, hearing loss, inhalation of toxic fumes, and burns. This protective equipment includes but is not limited to:</p> <ul style="list-style-type: none"> • Protective eye wear, and hearing protection. • Respirators, protective clothing, and gloves as recommended by the fluid and solvent manufacturer. |

Component Identification A20 and A30

| | | |
|----|--|--|
| A | Airless spray gun | Dispenses fluid. |
| B | Power switch | Turns sprayer ON and OFF. |
| C | Pressure control knob | Increases (clockwise) and decreases (counter-clockwise) fluid pressure in pump, hose, and spray gun. |
| C1 | Setting Indicator | To select function, align symbol on pressure control knob with setting indicator, page 13. |
| D | Pump fluid outlet fitting | Threaded connection for paint hose. |
| G | Suction tube | Draws fluid from paint pail into pump. |
| H | Prime tube (with diffuser) | Drains fluid in system during priming and pressure relief. |
| J | Prime/Spray valve | <ul style="list-style-type: none"> • PRIME position directs fluid to prime tube. • SPRAY position directs pressurized fluid to paint hose. • Automatically relieves system pressure in overpressure situations. |
| L | Inlet screen | Prevents debris from entering pump. |
| M | Paint hose | Transports high-pressure fluid from pump to spray gun. |
| N | Handle | Used to help transport sprayer. |
| Q | Tip guard | Reduces risk of fluid injection injury. |
| R | Reversible spray tip | <ul style="list-style-type: none"> • Atomizes fluid being sprayed, forms spray pattern and controls fluid flow according to hole size. • Reverse unclogs plugged tips without disassembly. |
| S | Gun trigger safety lever (page 13) | Prevents accidental triggering of spray gun. |
| T | Gun fluid inlet fitting | Threaded connection for paint hose. |
| U | Power Flush attachment | Connects garden hose to suction tube for power flushing water-based fluids. |
| V | Gun fluid filter | Filters fluid entering spray gun to reduce tip clogs. |
| W | Pail hanger (A20 sprayer only) | For transporting pail by its handle. |
| X | Power cord | Supplies sprayer with electricity |
| Z | Pump priming button (A30 sprayer only) | Manually taps inlet ball to loosen if stuck. |
| AA | Garden Hose Adapter | Connects to Power Flush Attachment and garden hose |

Component Identification A20 and A30

A20 Shown

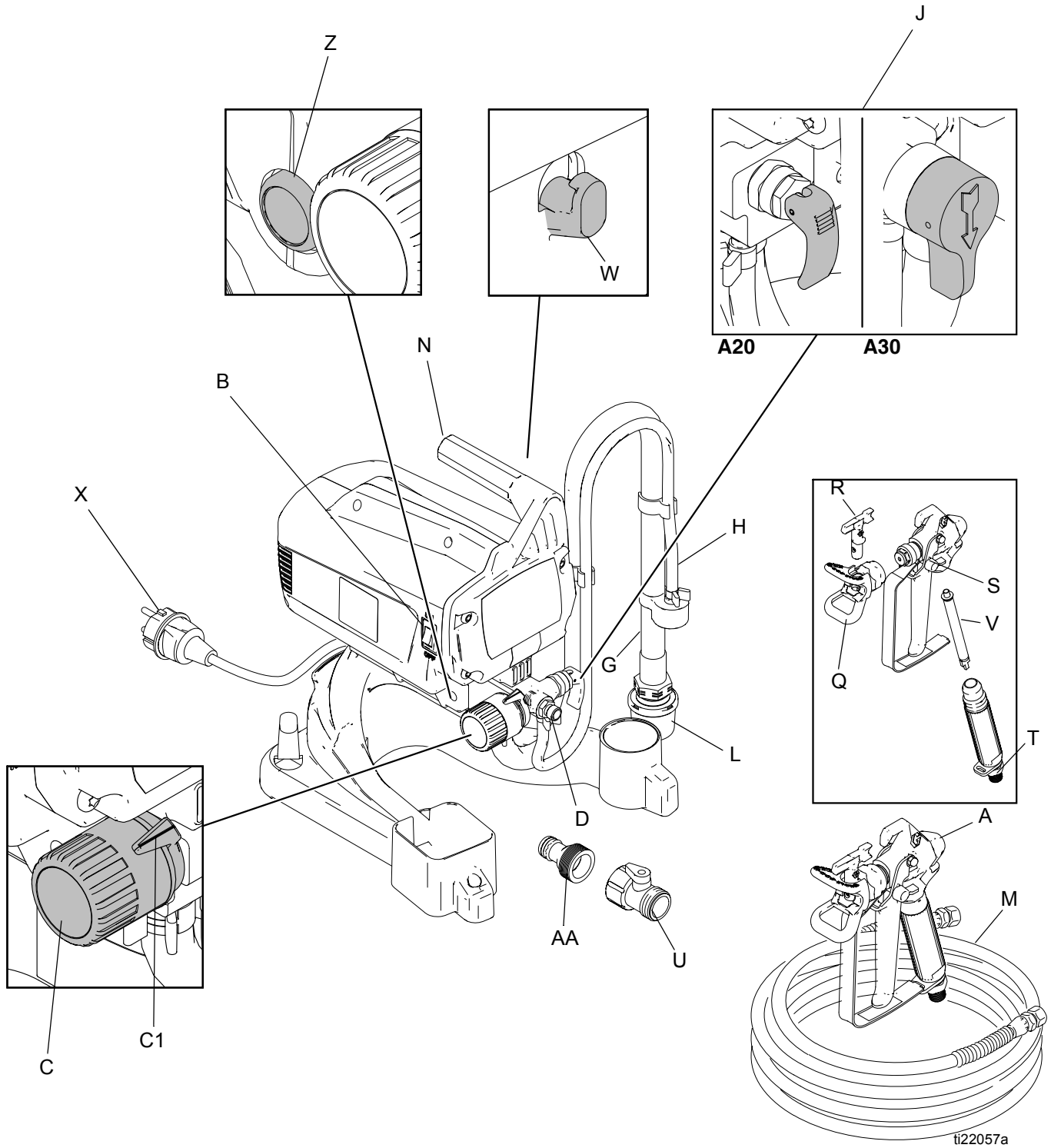

Component Identification A45 and A60

| | | |
|----|--|--|
| A | Airless spray gun | Dispenses fluid. |
| B | Power switch | Turns sprayer ON and OFF. |
| C | Pressure control knob | Increases (clockwise) and decreases (counter-clockwise) fluid pressure in pump, hose, and spray gun. |
| C1 | Setting Indicator | To select function, align symbol on pressure control knob with setting indicator, page 13. |
| D | Pump fluid outlet fitting | Threaded connection for paint hose. |
| E | InstaClean™ fluid filter (A60 Sprayer Only) | <ul style="list-style-type: none"> Filters fluid coming out of pump to reduce tip plugging and improve finish. Self cleans only during pressure relief. |
| F | Power-Piston™ Pump (Not shown. Behind Easy Access door) (A60 Sprayer Only) | Pumps and pressurizes fluid and delivers it to paint hose. |
| F1 | Easy Access door (A60 Sprayer Only) | Easy Access door permits quick access to outlet valve. To remove door, insert flat blade of screwdriver into slot on the bottom of the door (as shown on page, 11). |
| G | Suction tube | Draws fluid from paint pail into pump. |
| H | Prime tube (with diffuser) | Drains fluid in system during priming and pressure relief. |
| J | Prime/Spray valve | <ul style="list-style-type: none"> PRIME position directs fluid to prime tube. SPRAY position directs pressurized fluid to paint hose. Automatically relieves system pressure in overpressure situations. |
| K | Autoprime (A60 Sprayer Only) | Automatically taps the inlet ball when you turn the sprayer on. |
| L | Inlet screen | Prevents debris from entering pump. |
| M | Paint hose | Transports high-pressure fluid from pump to spray gun. |
| Q | Tip guard | Reduces risk of fluid injection injury. |
| R | Reversible spray tip | <ul style="list-style-type: none"> Atomizes fluid being sprayed, forms spray pattern and controls fluid flow according to hole size. Reverse unclogs plugged tips without disassembly. |
| S | Gun trigger safety lever (page 13) | Prevents accidental triggering of spray gun. |
| T | Gun fluid inlet fitting | Threaded connection for paint hose. |
| U | Power Flush attachment | Connects garden hose to suction tube for power flushing water-based fluids. |
| V | Gun fluid filter | Filters fluid entering spray gun to reduce tip clogs. |
| W | Hose wrap Rack | Stows paint hose. |
| X | Pail hanger | For transporting pail by its handle. |
| Y | Power Cord | Supplies sprayer with electricity. |
| Z | Power Flush Adapter (A60 Sprayer Only) | Adapts suction tube (G) to Power Flush attachment (U). |
| AA | Pump Priming Button (A45 Sprayer only) | Manually taps inlet ball to loosen if stuck. |
| AB | Garden Hose Adapter | Connects to Power Flush Attachment and garden hose |

Component Identification A45 and A60 A60 Shown

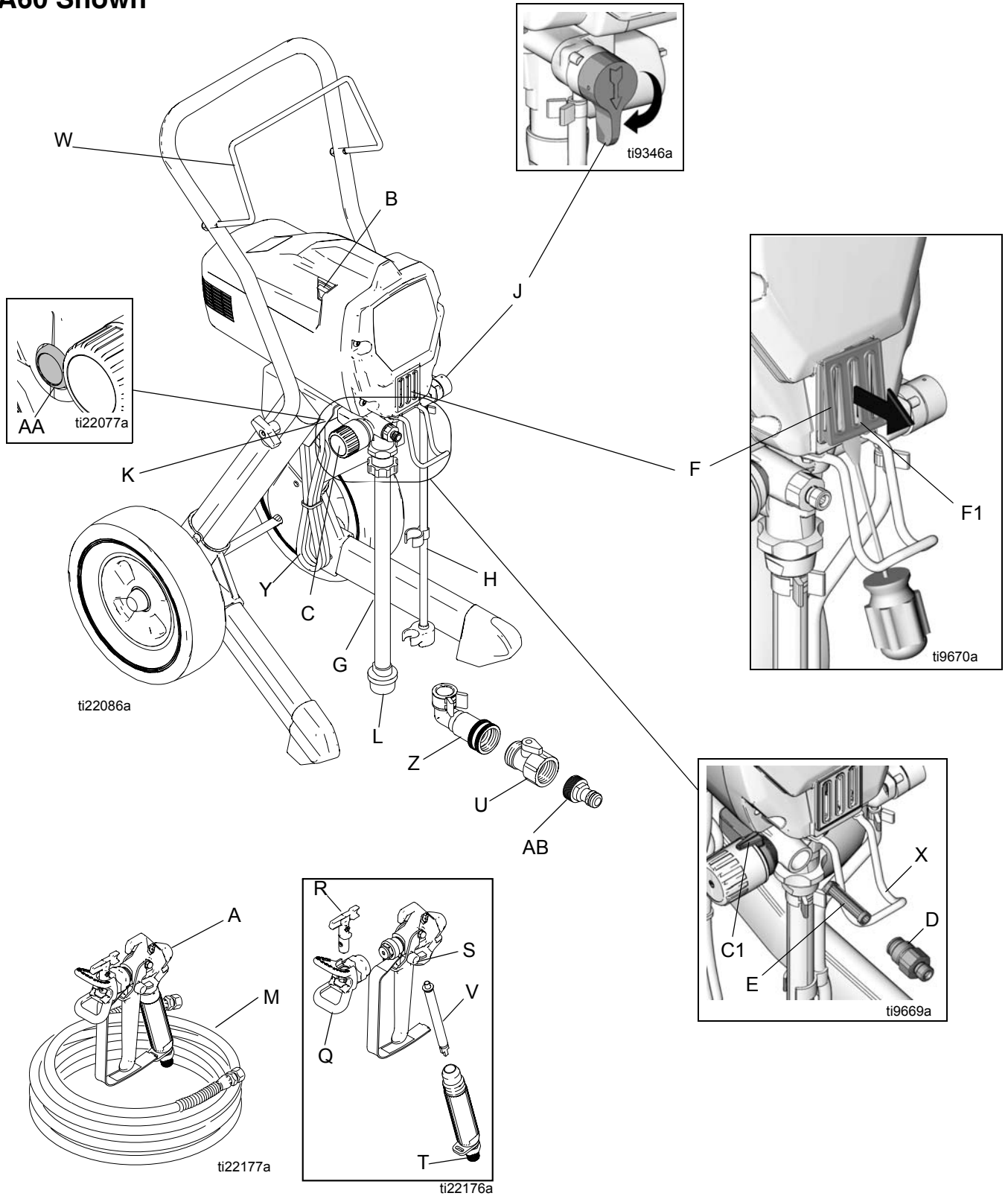

Grounding and Electric Requirements



Sprayer must be grounded. Grounding reduces the risk of static and electric shock by providing an escape wire for electrical current due to static build up or in the event of a short circuit.

- The 240 VAC sprayers require a 220-240 VAC, 50/60 Hz, 10A circuit with a grounding receptacle.
- Never use an outlet that is not grounded or an adapter.
- Do not use the sprayer if the electrical cord has a damaged ground prong.
- Only use an extension cord with an undamaged 3-prong plug. Recommended extension cords for use with this sprayer:
 - 15 m (49.2 ft) 1.0 mm²
 - 30 m (98.4 ft) 1.5 mm²
 - 50 m (164.0 ft) 2.5 mm²

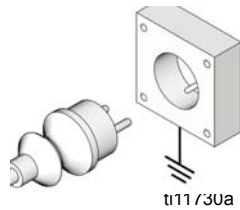

Spray gun: ground through connection to a properly grounded fluid hose and pump.

NOTE: Smaller gauge or longer extension cords may reduce sprayer performance.

Fluid supply container: follow local code.

Solvent pails used when flushing: follow local code. Use only conductive metal pails, placed on a grounded surface such as concrete. Do not place the pail on a nonconductive surface, such as paper or cardboard, which interrupts grounding continuity.

Grounding the metal pail: connect a ground wire to the pail by clamping one end to pail and other end to ground such as a water pipe.

Maintaining grounding continuity: when flushing or relieving pressure hold metal part of the spray gun firmly to the side of a grounded metal pail, then trigger the gun.



Thermal Overload

Motor has a thermal overload switch to shut itself down if overheated. If unit overheats, allow approximately 45 minutes for unit to cool. Once cool, switch will close and unit will restart.



To reduce risk of injury from motor starting unexpectedly when it cools, always turn power switch OFF if motor shuts down.

Operation

Trigger Lock

Always engage the trigger lock when you stop spraying to prevent the gun from being triggered accidentally by hand or if dropped or bumped.

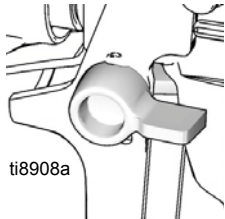

Trigger Locked

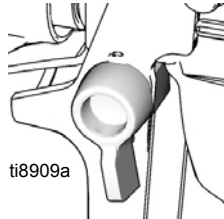

Trigger Unlocked

Pressure Relief Procedure

Follow this **Pressure Relief Procedure** whenever you stop spraying and before cleaning, checking, servicing, or transporting equipment.



1. Turn power switch OFF and unplug power cord.

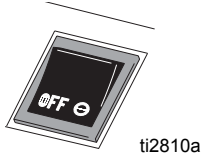

2. Move Prime/Spray valve to PRIME to relieve pressure.

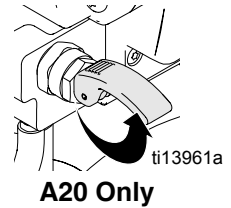
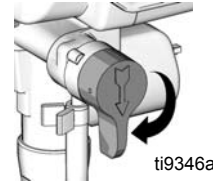

3. Hold gun firmly to side of pail. Trigger the gun to relieve pressure.



4. Engage trigger lock.

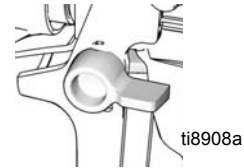

NOTE: Leave Prime/Spray valve in the PRIME position until you are ready to spray again.

If you suspect the spray tip or hose is clogged or that pressure has not been fully relieved after following the steps above, **VERY SLOWLY** loosen tip guard retaining nut or hose end coupling to relieve pressure gradually, then loosen completely. Clear hose or tip obstruction. Read Unclogging Spray Tip, page 18.

Pressure Control Knob Settings

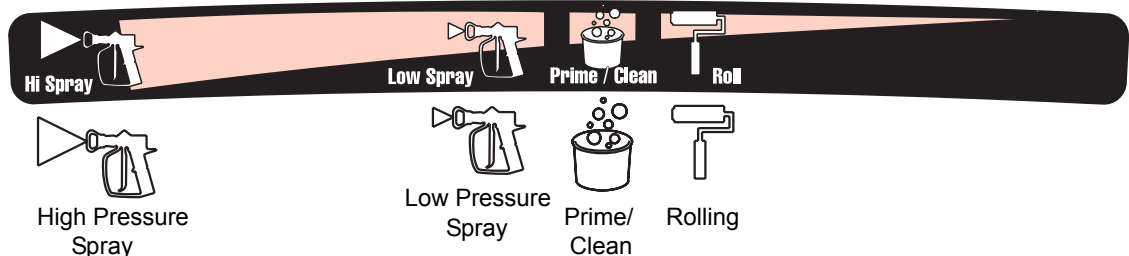

NOTE: To select function, align symbol on pressure control knob with setting indicator on sprayer.

Setup

Prime and Flush Storage Fluid

NOTE: To spray lacquers with the A60, you must purchase lacquer conversion kit 256212, and follow priming procedure for oil-based materials. The A20, A30, and A45 units are not intended for lacquers.

Before you use your sprayer for the first time or begin a new spraying project, you need to prime the sprayer and flush the storage fluid out of the sprayer.

Oil- or Water-based Materials

- When spraying **water-based** materials, flush the system thoroughly with water.
- When spraying **oil-based** materials, flush the system thoroughly with mineral spirits or compatible, oil-based flushing solvent.
- To spray **water-based** materials **after spraying oil-based** materials, flush the system thoroughly with water first. The water flowing out of prime tube should be clear and solvent-free **before** you begin spraying the water-based material.
- To spray **oil-based** materials **after spraying water-based** materials, flush the system thoroughly with mineral spirits or a compatible oil-based flushing solvent first. The solvent flowing out of the prime tube should not contain any water.
- When flushing with solvents, ground pail and gun. Read Grounding and Electric Requirements, page 12.
- To avoid fluid splashing back on your skin or into your eyes, always aim gun at inside wall of pail.

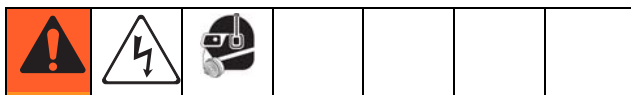

1. Unscrew tip and guard assembly from gun.

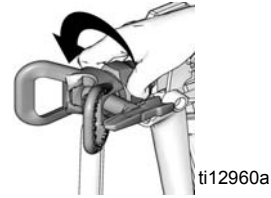

2. Uncoil hose and connect one end to gun. Use two wrenches to tighten securely.

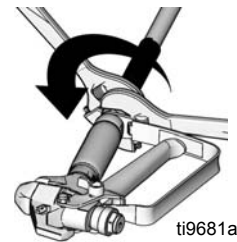

3. Connect other end of hose to sprayer.

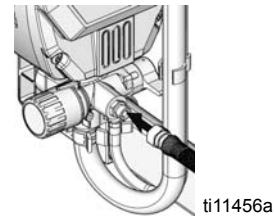

NOTE: If hose is already connected, make sure connections are tight.

4. Turn Pressure Control Knob all the way left (counter-clockwise) to minimum pressure.

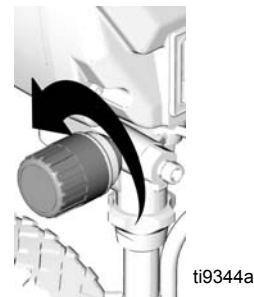

5. Make sure the power switch is OFF and the sprayer is unplugged.

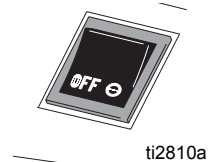

6. Separate prime tube (smaller) from suction tube (larger).

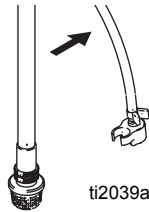

7. Place prime tube in waste pail.

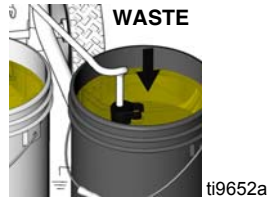

8. Submerge suction tube in water or flushing solvent.

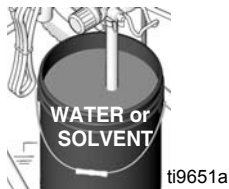

9. Move Prime/Spray Valve to PRIME.

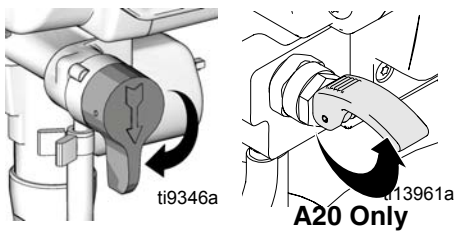

10. Plug sprayer in a grounded outlet.

11. Push pump priming button two times.

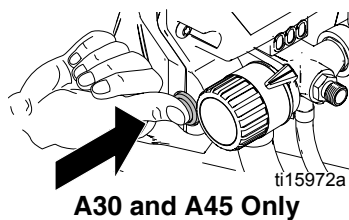

12. Turn power switch ON.

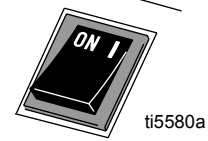

13. Align setting indicator with Prime/Clean setting on Pressure Control knob until pump starts, page 13.

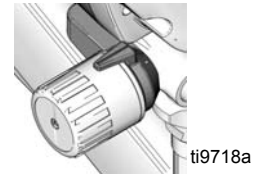

14. When sprayer starts pumping, flushing solvent and air bubbles will be purged from system. Allow fluid to flow out of prime tube, into waste pail, for 30 to 60 seconds.

15. Turn power switch OFF.

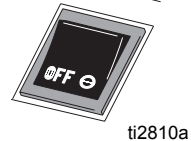

16. Transfer suction tube to paint pail and submerge suction tube in paint.

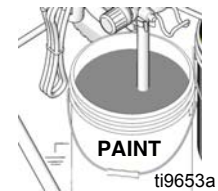

17. Turn power switch ON.

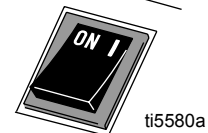

18. When you see paint coming out of prime tube:

- a. Point gun into waste pail.
- b. Unlock gun trigger lock.

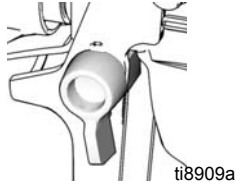

- c. Pull and hold gun trigger.
- d. Move Prime/Spray valve to SPRAY.

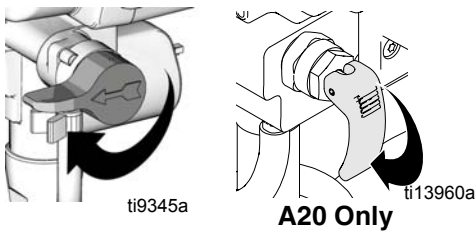

NOTE: Some fluids may prime faster if the Power Switch is momentarily turned off so the pump can slow and stop. Repeat several times if necessary.

19. Continue to trigger gun into waste pail until you see only paint coming out of gun.

20. Release trigger. Engage trigger lock.

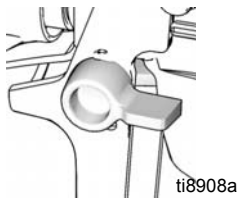

21. Transfer prime tube to paint pail and clip prime tube to suction tube.

NOTE: Motor stopping indicates pump and hose are primed with paint. If motor continues to run the sprayer is not properly primed. To reprime, move Prime/Spray valve to PRIME and repeat step 18.

Install Tip and Guard on Gun



1. Engage trigger lock.

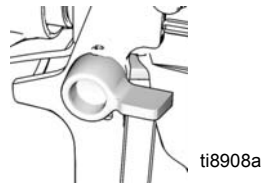

2. Verify tip and guard parts are assembled in order shown.

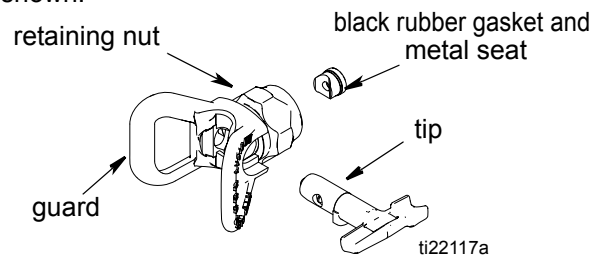

Use tip to align seat in guard

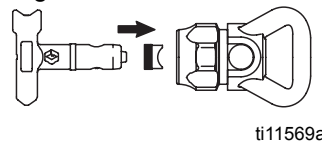

Tip must be pushed all the way into guard

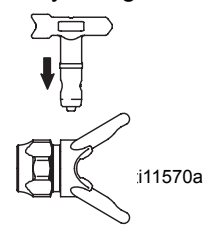

3. Screw tip and guard assembly on gun. Tighten retaining nut.

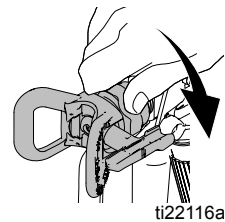

Spraying Techniques

Preventing Excessive Tip Wear

- Spray should be atomized (evenly distributed, no gaps at edges). Start at low pressure setting, increase pressure a little at a time until you see a good spray pattern, without tails.
- Spray at lowest pressure that atomizes paint.
- If maximum sprayer pressure is not enough for a good spray pattern, tip is too worn. See Reversible Spray Tip Selection Chart, page 19.

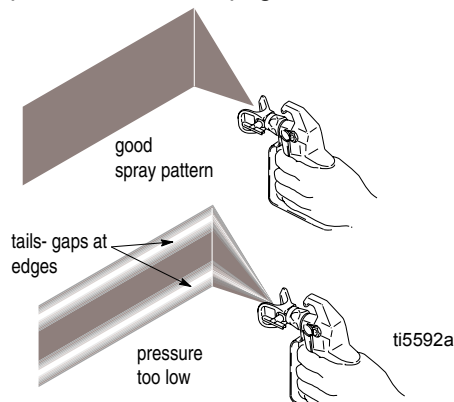

NOTE: If tails persist when spraying at the highest pressure, a smaller tip is needed or the material may need to be thinned.

Adjust Spray Pressure

This sprayer is set up for most airless spraying applications. Details on tip selection, tip wear, coat thickness, etc. are provided on page 18.



NOTE: Motor only runs when gun is triggered. Sprayer is designed to stop pumping when gun trigger is released.

Align setting indicator with function symbol on Pressure Control knob, page 13.

- Turning knob to the right (clockwise), increases pressure at gun.
- Turning knob to the left (counter-clockwise), decreases pressure at gun.

Getting Started

Use a piece of scrap cardboard to practice these basic spraying techniques before you begin spraying the surface.

- Hold gun 30 cm (12 in.) from surface and aim straight at surface. Tilting gun to direct spray angle causes an uneven finish.

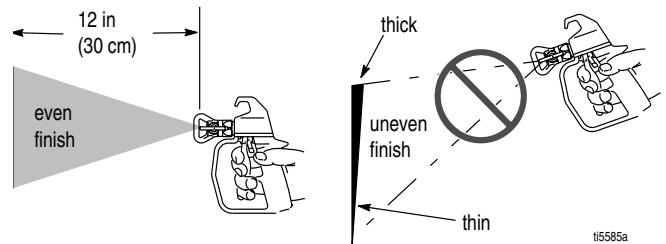

- Flex wrist to keep gun pointed straight. Fanning gun to direct spray at angle causes uneven finish.

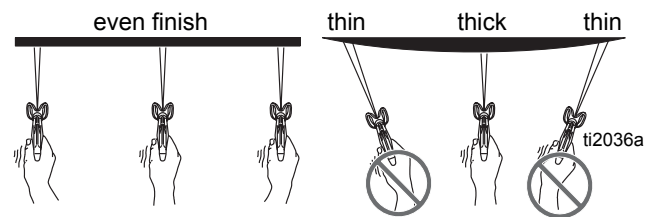

Triggering Gun

Pull trigger after starting stroke. Release trigger before end of stroke. Gun must be moving when trigger is pulled and released.

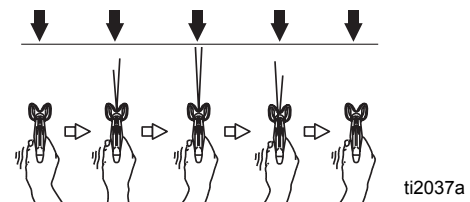

Aiming Gun

Aim tip of gun at bottom edge of previous stroke, overlapping each stroke by half.

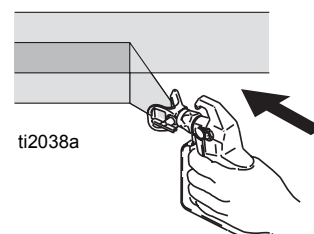

Unclogging Spray Tip



To avoid fluid splash back

- Never pull gun trigger when arrow-shaped handle is between SPRAY and UNCLOG positions.
- Tip must be pushed all the way into guard.

1. To UNCLOG tip obstruction, engage trigger lock.

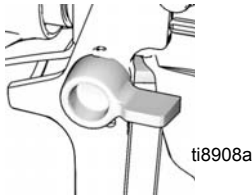

2. Point arrow-shaped handle backward to UNCLOG position.

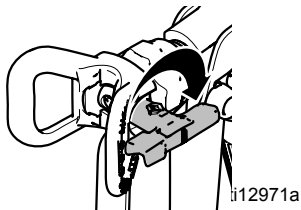

3. Aim gun at piece of scrap or cardboard.
4. Unlock trigger lock. Pull trigger to clear clog.

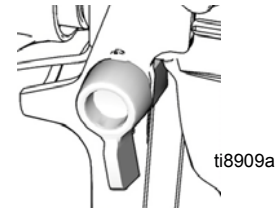

5. When obstruction is cleared, engage trigger lock and rotate arrow-shaped handle back to SPRAY position.

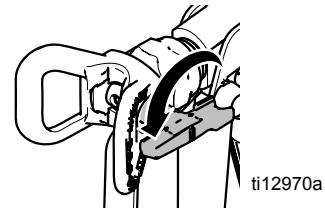

HINT: Point the arrow-shaped handle on the spray tip forward to SPRAY and backward to UNCLOG obstructions.

Tip Selection

Selecting Tip Hole Size

Tips come in a variety of hole sizes for spraying a range of fluids. Your sprayer includes an 0.015 in (0.38 mm) tip for use in most spraying applications. Use the following table to determine the range of recommended tip hole sizes for each fluid type. If you need a tip other than the one supplied, see the **Reversible Tip Selection Chart** on page 19.

HINT:

As you spray, the tip wears and enlarges. Starting with a tip hole size smaller than the maximum will allow you to spray within the rated flow capacity of the sprayer.

| Tip Hole Size | Coatings | | | | | |
|---------------------|----------|---------|---------|-----------------|-----------------|----------|
| | Stains | Enamels | Primers | Interior Paints | Exterior Paints | Acrylics |
| 0.011 in. (0.28 mm) | ✓ | | | | | |
| 0.013 in. (0.33 mm) | ✓ | ✓ | ✓ | ✓ | | |
| 0.015 in. (0.38 mm) | | ✓ | ✓ | ✓ | ✓ | |
| 0.017 in. (0.43 mm) | | | ✓ | ✓ | ✓ | ✓ |
| 0.019 in. (0.48 mm) | | | | | ✓ | ✓ |

Choosing the Correct Tip

Consider coating and surface to be sprayed. Make sure you use best tip hole size for that coating and best fan width for that surface.

Tip Hole Size

Tip hole size controls flow rate - the amount of paint that comes out of the gun.

HINTS:

- Use larger tip hole sizes with thicker coatings and smaller tip hole sizes with thinner coatings.
- Maximum tip hole sizes supported by sprayer:
 - A20 and A30: 0.015 in. (0.38 mm)
 - A45: 0.017 in. (0.43 mm)
 - A60: 0.019 in. (0.48 mm)
- Tips wear with use and need periodic replacement.

Fan Width

Fan width is the size of the spray pattern, which determines the area covered with each stroke. Narrower fans deliver a thicker coat, and wider fans deliver a thinner coat.

HINTS:

- Select a fan width best suited to the surface being sprayed.
- Wider fans provide better coverage on broad, open surfaces.
- Narrower fans provide better control on small, confined surfaces.

Understanding Tip Number

The last three digits of tip number (i.e.: 16X413) contain information about hole size and fan width on surface when gun is held 30 cm (12 in.) from surface being sprayed.

First digit when doubled = approximate fan width

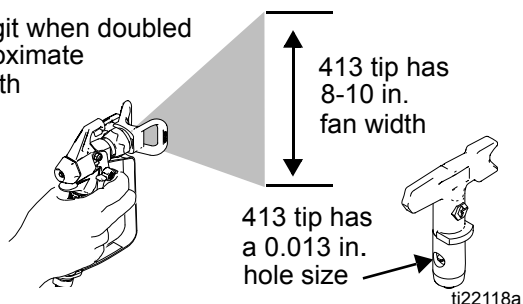

Last two digits = tip hole size in thousands of an inch

Reversible Tip Selection Chart

| Tip Part No. | Fan Width 30 cm (12 in.) from surface | Hole Size |
|--------------|---------------------------------------|------------------------|
| 16X311 | 6 - 8 in. (152 - 203 mm) | 0.011 in. (0.28 mm) |
| 16X411 | 8 - 10 in. (203 - 254 mm) | 0.011 in. (0.28 mm) |
| 16X313 | 6 - 8 in. (152 - 203 mm) | 0.013 in. (0.33 mm) |
| 16X413 | 8 - 10 in. (203 - 254 mm) | 0.013 in. (0.33 mm) |
| 16X415 | 8 - 10 in. (203 - 254 mm) | 0.015 in. (0.38 mm) |
| 16X515 | 10 - 12 in. (254 - 305 mm) | 0.015 in. (0.38 mm) |
| 16X417 | 8 - 10 in. (203 - 254 mm) | 0.017 in. (0.43 mm) |
| 16X517 | 10 - 12 in. (254 - 305 mm) | 0.017 in. (0.43 mm) |
| 16X619 | 12 - 14 in. (305 - 356 mm) | 0.019 in. (0.48 mm) |

Example: For an 8 to 10 in. (203 to 254 mm) fan width and 0.013 in. (0.33 mm) hole size, order Part No. 16X413.

Shutdown and Cleaning

Pail Flushing

- For short term shutdown periods (overnight to two days) refer to Short Term Storage, page 25.
- For flushing after spraying oil-based coatings, use compatible oil-based flushing fluid or mineral spirits. Read Priming and Flushing Storage Fluid, page 14.
- For flushing after spraying water-based coatings, use water. Read Priming and Flushing Storage Fluid, page 14 or Power Flush, page 22.



1. **Relieve pressure**, page 13.
2. Remove tip and guard assembly from gun and place in flushing fluid.
3. Place empty waste and water or solvent pails side by side.

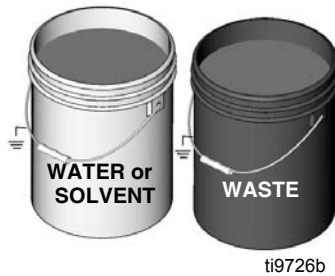

4. Lift suction tube and prime tube from paint pail. Let them drain into paint pail for a while.
5. Separate prime tube (smaller) from suction tube (larger).

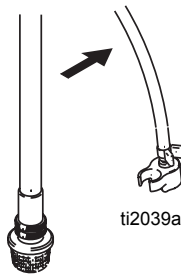

6. Place prime tube in waste pail.

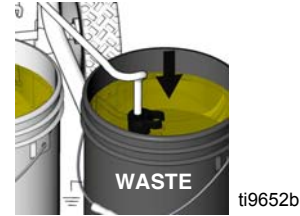

7. Submerge suction tube in water or flushing solvent.

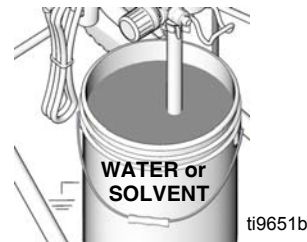

8. Turn pressure control knob to the Prime/Clean setting.

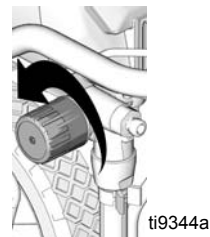

9. Turn power switch ON.

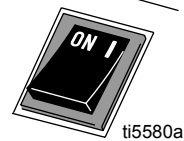

10. Flush until approximately 1/3 of the flushing fluid is emptied from the pail.

11. Turn power switch OFF.

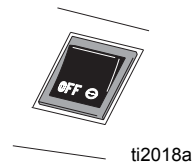

NOTE: Step 12 is for returning paint in hose back to paint pail. One 50-ft hose holds approximately 1-quart (1-liter) of paint.

12. To preserve paint in hose:

- a. Point gun into paint pail.
- b. Unlock gun trigger lock.

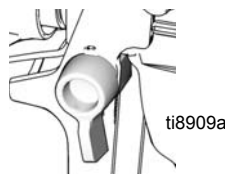

- c. Pull and hold gun trigger.
- d. Move Prime/Spray valve to SPRAY.

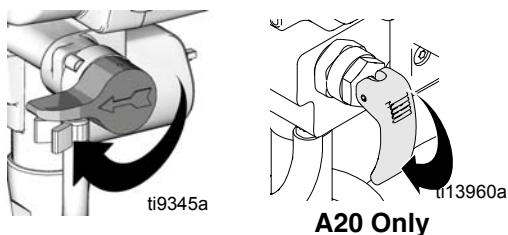

- e. Turn power switch ON.

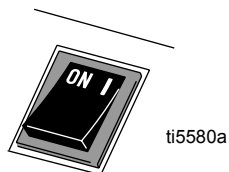

- f. Continue to hold gun trigger until you see paint diluted with flushing fluid starting to come out of gun.

13. While continuing to trigger gun, quickly move gun to redirect spray into waste pail. Continue triggering gun into waste pail until flushing fluid dispensed from gun is relatively clear.



14. Stop triggering gun. Engage the trigger lock.

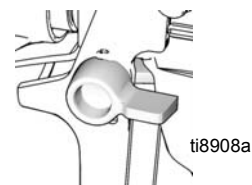

15. Move Prime/Spray valve to PRIME.

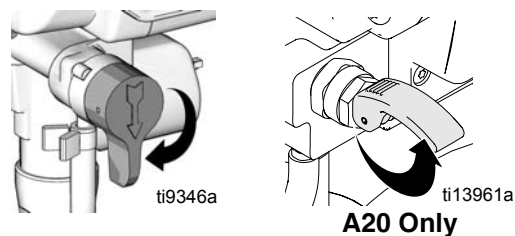

16. Turn power switch OFF.

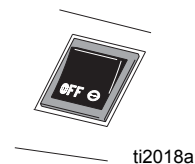

17. Clean InstaClean™ Fluid Filter and gun, page 24.

18. Fill unit with Pump Armor™ storage fluid. Read Long Term Storage, page 25.

Power Flush

Power flushing is a faster method of flushing. It can only be used after spraying water-based coatings.

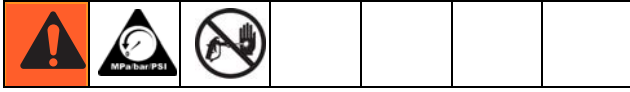

1. **Relieve pressure**, page 13.
2. Remove tip and guard assembly from gun and place in waste pail.
3. Place empty waste and paint pails side by side.



4. Lift suction tube and prime tube from paint pail. Let them drain into paint for a while.
5. Place suction and prime tube in waste pail.
6. Turn Pressure Control knob to the Prime/Clean setting.

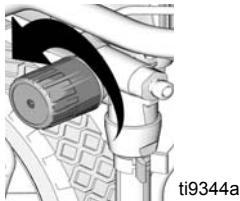

7. Screw Power Flush attachment to garden hose. Close valve.



8. Turn on water. Open valve. Rinse paint off suction tube, prime tube and inlet screen.

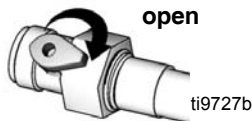

9. Close valve on Power Flush attachment.



10. Unscrew inlet screen from suction tube. Place inlet screen in waste pail.

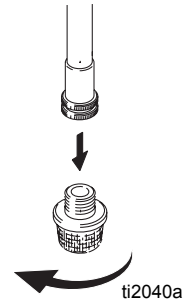

11. Connect garden hose to suction tube with Power Flush attachment. Leave prime tube in waste pail.

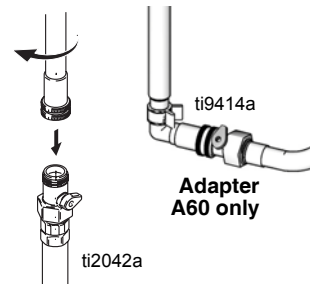

12. Turn power switch ON.

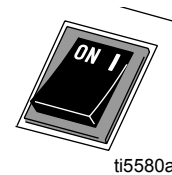

13. Open valve on Power Flush attachment.

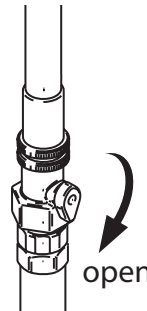

14. Circulate water through sprayer, into waste pail, for 20 seconds.

15. Turn power switch OFF.

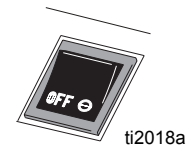

NOTE: Step 16 is for returning paint in hose back to paint pail. One 50-ft (15-m) hose holds approximately 1-quart (1-liter) of paint.

16. To preserve paint in hose:

- a. Point gun into paint pail.
- b. Unlock gun trigger lock.

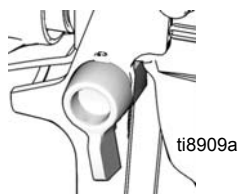

- c. Pull and hold gun trigger.
- d. Move Prime/Spray valve to SPRAY.

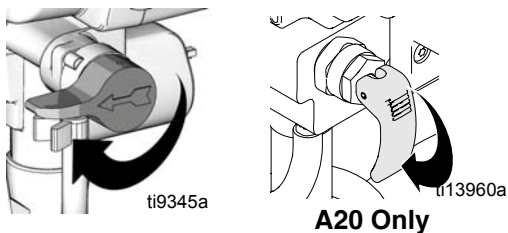

e. Turn power switch ON.

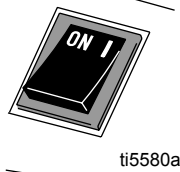

f. Continue to hold gun trigger until you see paint diluted with water starting to come out of gun.

17. While continuing to trigger gun, quickly move gun to redirect spray into waste pail. Continue triggering gun into waste pail until water coming out of gun is relatively clear.



18. Stop triggering gun. Engage trigger lock.

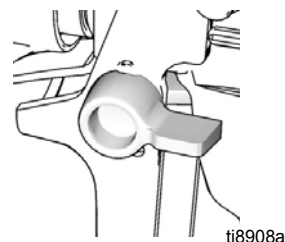

19. Move Prime/Spray valve to PRIME.

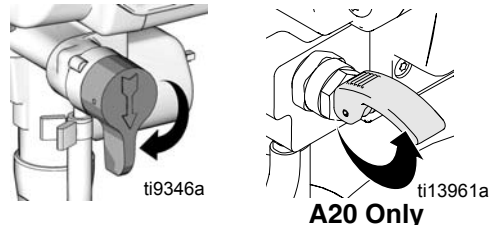

20. Turn power switch OFF.

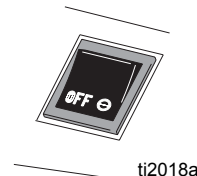

21. Turn off garden hose. Close valve on Power Flush attachment.

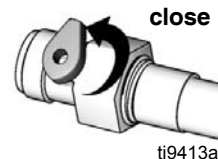

22. Unscrew Power Flush attachment from suction tube.

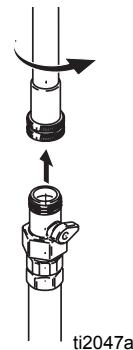

23. Clean InstaClean™ Fluid Filter and gun, page 24.

24. Fill unit with Pump Armor™ storage fluid. Read Long Term Storage, page 25.

Cleaning InstaClean™ Fluid Filter (A60 Only)

The InstaClean™ Fluid Filter prevents particles from entering paint hose. After each use, remove and clean it to ensure peak performance.



1. **Relieve pressure**, page 13.
2.
 - a. Disconnect airless spray hose (a) from sprayer
 - b. Unscrew outlet fitting (b).
 - c. Remove InstaClean™ Fluid Filter (c).

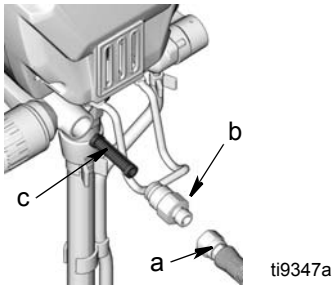

3. Check InstaClean™ Fluid Filter (c) for debris. If needed, clean filter with water and a soft brush.
 - a. Install closed (square) end of InstaClean™ Fluid Filter (c) in sprayer.
 - b. Screw outlet fitting (b) into sprayer.

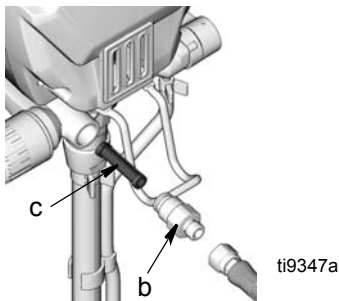

4. Tighten outlet fitting and reconnect hose (a) to sprayer. Use two wrenches to tighten securely.

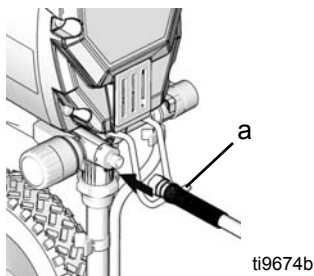

Cleaning Gun

- Clean gun fluid filter (d) with water or flushing solvent and a brush every time you flush the system. Replace gun filter if damaged.

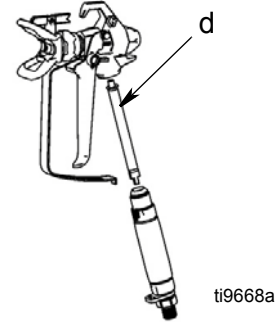

- Remove tip and guard and clean with water or flushing solvent. A soft brush can be used to loosen and remove dried on material if needed.

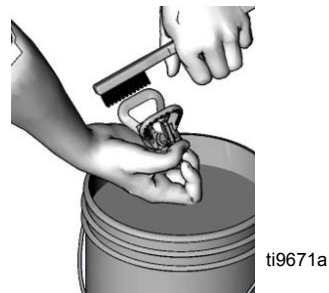

- Wipe paint off outside of gun using a soft cloth moistened with water or flushing solvent.

Storage

Short Term Storage

(up to 2 days)



1. **Relieve pressure**, page 13.
2. Leave suction tube and prime tube in paint pail.

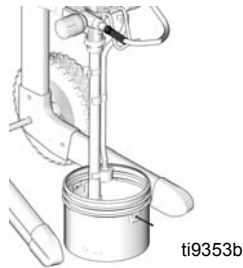

3. Cover paint pail and hoses tightly with plastic wrap.



4.
 - a. Engage trigger lock.

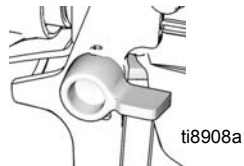

- b. Leave gun attached to hose.
- c. If you have not already cleaned them, remove tip and guard from gun and clean with water or flushing solvent. A soft brush can be used to loosen and remove dried on material if needed.



- d. Wipe paint off outside of gun using a soft cloth moistened with water or flushing solvent.

Long Term Storage

(more than 2 days)



Always circulate Pump Armor storage fluid through system after cleaning. Water left in sprayer will corrode and damage pump. Follow Shutdown and Cleaning, page 20, or Power Flush Cleaning, page 22.

1. Place suction tube in Pump Armor storage fluid bottle and prime tube in waste pail.

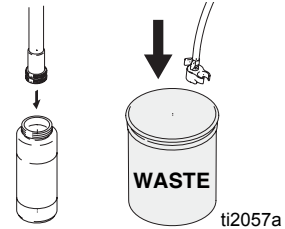

2. Move Prime/Spray valve to PRIME.

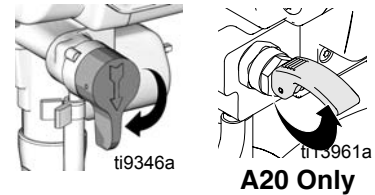

3. Turn power switch ON.

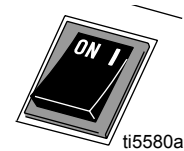

4. Turn pressure control knob clockwise until the pump turns on.

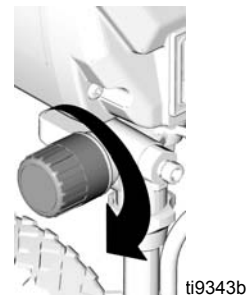

Storage

- When storage fluid comes out of prime tube (5-10 seconds) turn power switch OFF.

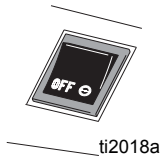

- Move Prime/Spray valve to SPRAY to keep storage fluid in sprayer during storage.

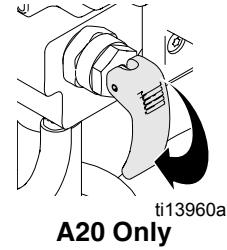
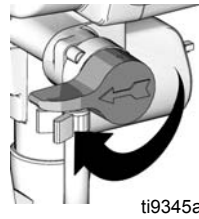

Stowing Sprayer

NOTICE

- Before storing sprayer make sure all water is drained out of sprayer and hoses.
- Do not allow water to freeze in sprayer or hose.
- Do not store sprayer under pressure.

- Screw inlet screen onto suction tube.

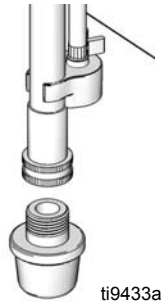

- Secure a plastic bag around suction tube to catch any drips.

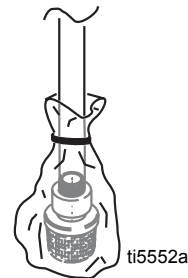

- Coil hose. Leave it connected to sprayer. Wrap hose around hose wrap bracket or sprayer stand.

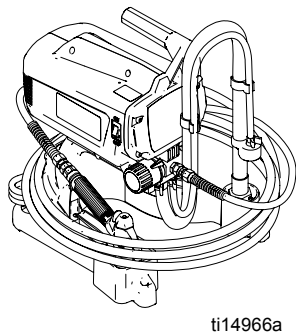
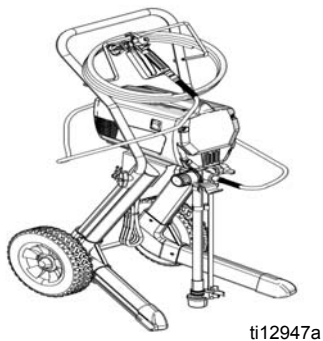

- Store sprayer indoors.

Maintenance and Service

NOTICE

Protect the internal drive parts of this sprayer from water. Openings in shroud allow cooling of mechanical parts and electronics inside. If water gets into these openings, the sprayer could malfunction or be permanently damaged.

Caring for Sprayer

Keep sprayer and all accessories clean and in good working order.

To avoid overheating motor, keep vent holes in shroud clear for air flow. Do not cover sprayer while spraying.

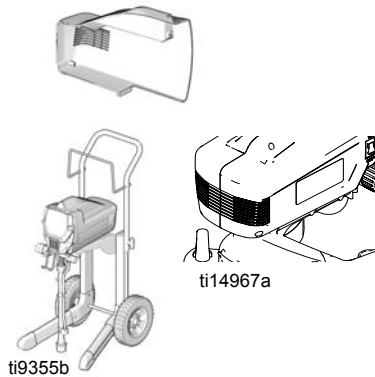

Paint Hoses

Check hose for damage every time you spray. Do not attempt to repair hose if hose jacket or fittings are damaged. Do not use hoses shorter than 7.5 m (25 ft). Wrench tighten, using two wrenches.

Tips

- Always clean tips with compatible solvent and brush after spraying.
- Tips may require replacement after 57 liters (15 gallons) or they may last through 227 liters (60 gallons) depending on abrasiveness of paint.
- Do not spray with worn tip.

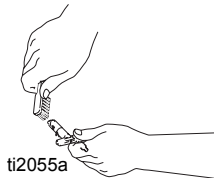

Pump Check Valves

- Storing in water, inadequate flushing or ingested debris can cause either of the two check valves to malfunction.
- If pump does not prime after 30 seconds, try to loosen check balls by pushing pump priming button (A30 and A45 only) or by tapping the inlet valve with a small wrench as the sprayer is stroking.

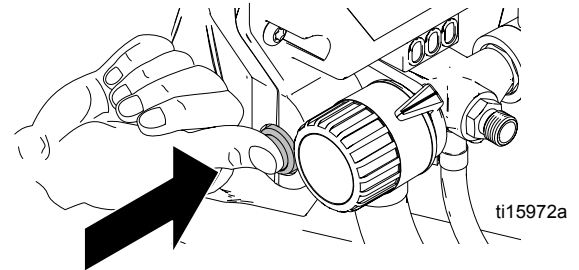

A30 and A45 Only

NOTICE

Excessive shock will fracture or cause damage to pump.

NOTE: To verify inlet valve ball is sticking, unscrew valves from pump and check them.

If sprayer continues to cycle (motor and pump run) after you release gun trigger, pump valves may be obstructed or worn. Valve repair kits are available from Graco/Magnum authorized service dealers.

Pump Packings

When pump packings wear, paint will begin to leak down outside of pump.

- Replace pump packings at first sign of leaking or additional damage could occur.
- Purchase a pump repair kit and install according to instructions provided with kit.
- Consult a Graco/MAGNUM authorized service center.

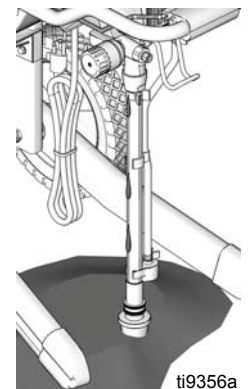

Troubleshooting



Check everything in this Troubleshooting Table before you bring the sprayer to a Graco/MAGNUM authorized service center.

| Problem | Cause | Solution |
|--|---|---|
| Power switch is on and sprayer is plugged in, but motor does not run, and pump does not cycle. | Pressure is set at zero pressure. | Turn pressure control knob clockwise to increase pressure setting. |
| | Motor or control is damaged. | Take sprayer to Graco/MAGNUM authorized service center. |
| | Electric outlet is not providing power. | <ul style="list-style-type: none"> • Try a different outlet or plug in something that you know is working to test outlet. • Reset building circuit breaker or replace fuse. |
| | Extension cord is damaged. | Replace extension cord. Read Grounding and Electric Requirements, page 12. |
| | Sprayer power cord is damaged. | Check for broken insulation or wires. Replace power cord if damaged. |
| | Paint and/or water is frozen or hardened in pump. | Unplug sprayer from outlet. If frozen do NOT try to start sprayer until it is completely thawed or you may damage the motor, control board and/or drivetrain. Make sure power switch is OFF. Place sprayer in a warm area for several hours. Then plug in power cord and turn sprayer ON. Slowly increase pressure setting to see if motor will start. If paint is hardened in sprayer, pump packings, valves, drivetrain or pressure switch may need to be replaced. Take sprayer to Graco/MAGNUM authorized service center. |

| Problem | Cause | Solution |
|-------------------------------|--|---|
| Pump does not prime. | Prime/Spray Valve is in SPRAY position. | Move Prime/Spray Valve to PRIME position. |
| | Inlet screen is clogged or suction tube is not immersed in fluid. | Clean debris off inlet screen and make sure suction tube is immersed in fluid. |
| | Pump was not primed with flushing fluid. | Remove suction tube from paint. Prime pump with water or solvent-based flushing fluid, page 14. |
| | Inlet valve check ball is stuck. | Remove suction tube and place a pencil into the inlet section to dislodge the ball, press pump priming button, or Power Flush sprayer, page 22. |
| | | A60: AutoPrime may need replacement. Turn power switch ON and listen for “tap” in pump. If you do not hear “tap”, AutoPrime is damaged. Take sprayer to Graco/MAGNUM authorized service center. |
| | Inlet valve check ball or seat is dirty | Remove inlet fitting. Clean or replace ball and seat. |
| | Outlet valve check ball is stuck. | A60: Insert screw driver in slot and remove Easy-Access™ door, page 10. Unscrew outlet valve with a 3/4 in. socket. Remove and clean assembly. A20, A30, and A45: Remove outlet fitting and clean outlet check ball. |
| | Suction tube is leaking. | Tighten suction tube connection. Inspect for cracks or vacuum leaks. |
| | Pump does not prime with fluid. | Remove suction tube from paint. Prime pump with water or solvent-based flushing fluid. |
| Fluids are viscous or sticky. | Some fluids may prime faster if the Power Switch is momentarily turned off so the pump can slow and stop. Repeat several times if necessary. | |

| Problem | Cause | Solution |
|---|--|--|
| Pump cycles but does not build up pressure. | Pump is not primed. | Prime pump. |
| | Inlet screen is clogged. | Clean debris off inlet screen and make sure suction tube is immersed in fluid. |
| | Suction tube is not immersed in paint. | Make sure suction tube is immersed in paint. |
| | Suction tube is leaking. | Tighten suction tube connection. Inspect for cracks or vacuum leaks. If cracked or damaged, replace suction tube. |
| | Prime/Spray Valve is worn or obstructed with debris. | Take sprayer to Graco/MAGNUM authorized service center. |
| | Pump check ball is stuck. | Read <i>Pump does not prime</i> section in Troubleshooting, page 29 |
| Pump cycles, but paint only dribbles or spurts when spray gun is triggered. | Pressure is set too low. | Slowly turn Pressure Control Knob clockwise to increase pressure setting which will turn motor on to build pressure. |
| | Spray tip is clogged. | Unclog spray tip, page 18. |
| | InstaClean™ fluid filter is clogged. | Clean or replace InstaClean™ fluid filter, page 24. |
| | Spray gun fluid filter is clogged. | Clean or replace gun fluid filter, page 24. |
| | Spray tip is too large or worn. | Replace tip. |

| Problem | Cause | Solution |
|---|---|---|
| Pressure is set at maximum but cannot achieve a good spray pattern. | Reversible spray tip is in UNCLOG position. | Rotate arrow-shaped handle on spray tip so it points forward in SPRAY position, page 18. |
| | Spray tip is too large for sprayer. | Select smaller spray tip. |
| | Spray tip is worn beyond capability of sprayer. | Replace spray tip. |
| | Extension cord is too long or not heavy enough gauge. | Replace extension cord. Grounding and Electrical Requirements, page 12. |
| | Spray gun fluid filter is clogged. | Clean or replace spray gun fluid filter, page 24. |
| | InstaClean™ fluid filter is clogged. | Clean or replace InstaClean™ fluid filter, page 24. |
| | Inlet screen is clogged. | Clean debris off inlet screen. |
| | Pump valves are worn, or debris is clogging valve. | Check for worn pump valves. <ul style="list-style-type: none"> a. Prime sprayer with paint b. Trigger gun momentarily. When trigger is released, pump should cycle momentarily and stop. If pump continues to cycle, pump valves may be worn. c. Remove valves and check for debris. |
| | Material is too thick. | Thin material. |
| | Hose is too long (if extra section is added). | Remove section of hose. |
| Spray gun stopped spraying. | Suction tube is leaking. | Tighten suction tube connection. Inspect for cracks or vacuum leaks. |
| | Spray tip is clogged. | Unclog spray tip, page 18. |
| When paint is sprayed, it runs down the wall or sags. | Coat is going on too thick. | Move gun faster. |
| | | Choose a tip with smaller hole size. |
| | | Choose tip with wider fan. |
| | | Make sure gun is far enough from surface. |
| When paint is sprayed, coverage is inadequate. | Coat is going on too thin. | Move gun slower. |
| | | Choose tip with larger hole size. |
| | | Choose tip with narrower fan. |
| | | Make sure gun is close enough to surface. |

| Problem | Cause | Solution |
|--|---|---|
| Fan pattern varies dramatically while spraying. OR Sprayer does not turn on promptly when resuming spraying. | Pressure control switch is worn and causing excessive pressure variation. | Take sprayer to Graco/MAGNUM authorized service center. |
| Cannot trigger spray gun. | Spray gun trigger lock is locked. | Rotate trigger safety lever to unlock trigger lock, page 13. |
| Paint is coming out of pressure control switch. | Pressure control switch is worn. | Take sprayer to Graco/MAGNUM authorized service center. |
| Prime/Spray valve actuates automatically relieving pressure through prime tube. | System is over pressurizing. | Take sprayer to Graco/MAGNUM authorized service center. |
| Paint leaks down outside of pump. | Pump packings are worn. | Replace pump packings. |
| Motor is hot and runs intermittently. Motor automatically shuts off due to excessive heat. Damage can occur if cause is not corrected. See Thermal Overload , page 12. | Vent holes in enclosure are plugged or sprayer is covered. | Keep vent holes clear of obstructions and over spray and keep sprayer open to air. |
| | Extension cord is too long or not a heavy enough gauge. | Replace extension cord. Read Grounding and Electrical Requirements, page 12. |
| | Unregulated electrical generator being used has excessive voltage. | Use electrical generator with a proper voltage regulator. Sprayer requires 220-240 VAC, 50/60 Hz. |

Technical Data

| | A20 | A30 |
|--------------------------------|--|--------------------|
| Working pressure range | 0-207 BAR, 0-21 Mpa (0-3000 psi) | |
| Electric Motor | 4.5A (open frame, universal) | |
| Operating horsepower | 3/8 | 1/2 |
| Maximum delivery (with tip) | .91 lpm (.24 gpm) | 1.02 lpm (.27 gpm) |
| Paint hose | 6.4mm X 7.5 m (1/4 in. x 25 ft) | |
| Maximum tip hole size | 0.015 in (0.38 mm) | 0.015 in (0.38 mm) |
| Weight, Sprayer only | 4.5 kg (10.0 lb) | 6.0 kg (13.3 lb) |
| Weight, sprayer, hose, & gun | 6.0 kg (13.3 lb) | 7.5 kg (16.5lb) |
| Dimensions (Upright): | | |
| Length | 35.2 cm (13.8 in) | 34.8 cm (13.7 in) |
| Width | 30.7 cm (12.1 in) | 41.1 cm (16.2 in) |
| Height | 35.1 cm (13.8 in) | 46.3 cm (18.2 in) |
| Dimensions (Folded): | | |
| Length | N/A | N/A |
| Width | N/A | N/A |
| Height | N/A | N/A |
| Power cord | 1.0 mm ² , 3-wire, 1.8 m (6 ft) | |
| Fluid inlet fitting | 1/4 npsm external thread | |
| Fluid outlet fitting | 3/4 in. internally threaded (standard garden hose) | |
| Inlet screen (on suction tube) | 1190 micron (16 mesh) | |
| Wetted parts, pump and hose | stainless steel, zinc plated carbon steel, brass, ultra-high molecular weight polyethylene (UHMWPE), Carbide, Nylon, Aluminum, PVC, polypropylene, fluoroelastomer | |
| Wetted parts, gun | aluminum, brass, carbide, nylon, ultra-high molecular weight polyethylene (UHMWPE), zinc | |
| Generator requirement | 1500 Watt minimum | |
| Electrical power requirement | 220-240V AC 50/60 Hz, 1 phase, 10A | |
| Storage temperature range◆◆ | -35° to 71° C (-30° to 160° F) | |
| Operating temperature range✓ | 4° to 46° C (40° to 115° F) | |

- ◆ When pump is stored with non-freezing fluid. Pump damage will occur if water or latex paint freezes in pump.
- ◆ Damage to plastic parts may result if impact occurs in low temperature conditions.
- ✓ Changes in paint viscosity at very low or very high temperatures can affect sprayer performance.

| | A45 | A60 |
|--------------------------------|--|---|
| Working pressure range | 0-207 BAR, 0-21 Mpa (0-3000 psi) | |
| Electric Motor | 4.5A (open frame, universal) | 6.5A (open frame, permanent magnet DC) |
| Operating horsepower | 5/8 | 7/8 |
| Maximum delivery (with tip) | 1.17 lpm (.31 gpm) | 1.44 lpm (.38 gpm) |
| Paint hose | 6.4mm X 15 m (1/4 in. x 50 ft) | |
| Maximum tip hole size | 0.017 in (0.43 mm) | 0.019 in (0.48 mm) |
| Weight, Sprayer only | 10.6 kg (23.3 lb) | 15 kg (33.0 lb) |
| Weight, sprayer, hose, & gun | 12.7 kg (28 lb) | 17.1 kg (37.7 lb) |
| Dimensions (Upright): | | |
| Length | 49.0 cm (19.3 in) | 54 cm (21.3 in) |
| Width | 38.9 cm (15.3 in) | 43.8 cm (17.3 in) |
| Height | 94.0 cm (37.0 in) | 94.5 cm (37.2 in) |
| Dimensions (Folded): | | |
| Length | 49.0 cm (19.3 in) | 54 cm (21.3 in) |
| Width | 38.9 cm (15.3 in) | 43.8 cm (17.3 in) |
| Height | 74.2 cm (29.2 in) | 74.7 cm (29.4 in) |
| Power cord | 1.0 mm ² , 3-wire, 1.8 m (6 ft) | |
| Fluid inlet fitting | 1/4 npsm external thread | |
| Fluid outlet fitting | 3/4 in. internally threaded (standard garden hose) | 7/8 - 14 UNF external thread |
| Inlet screen (on suction tube) | 1190 micron (16 mesh) | 1680 micron (12 mesh) |
| Generator requirement | 1500 Watt minimum | |
| Wetted parts, pump and hose | stainless steel, zinc plated carbon steel, brass, ultra-high molecular weight polyethylene (UHMWPE), Carbide, Nylon, Aluminum, PVC, polypropylene, fluoroelastomer | stainless steel, zinc plated carbon steel, brass, leather, ultra-high molecular weight polyethylene (UHMWPE), Carbide, Nylon, Aluminum, PVC, polypropylene, fluoroelastomer |
| Wetted parts, gun | aluminum, brass, carbide, nylon, ultra-high molecular weight polyethylene (UHMWPE), zinc | |
| Electrical power requirement | 220-240V AC 50/60 Hz, I phase, 10A | |
| Storage temperature range◆❖ | -35° to 71° C (-30° to 160° F) | |
| Operating temperature range✓ | 4° to 46° C (40° to 115° F) | |

- ◆ When pump is stored with non-freezing fluid. Pump damage will occur if water or latex paint freezes in pump.
- ❖ Damage to plastic parts may result if impact occurs in low temperature conditions.
- ✓ Changes in paint viscosity at very low or very high temperatures can affect sprayer performance.

Graco Standard Warranty

Graco warrants all equipment referenced in this document which is manufactured by Graco and bearing its name to be free from defects in material and workmanship on the date of sale to the original purchaser for use. With the exception of any special, extended, or limited warranty published by Graco, Graco will, for a period of twelve months from the date of sale, repair or replace any part of the equipment determined by Graco to be defective. This warranty applies only when the equipment is installed, operated and maintained in accordance with Graco's written recommendations.

This warranty does not cover, and Graco shall not be liable for general wear and tear, or any malfunction, damage or wear caused by faulty installation, misapplication, abrasion, corrosion, inadequate or improper maintenance, negligence, accident, tampering, or substitution of non-Graco component parts. Nor shall Graco be liable for malfunction, damage or wear caused by the incompatibility of Graco equipment with structures, accessories, equipment or materials not supplied by Graco, or the improper design, manufacture, installation, operation or maintenance of structures, accessories, equipment or materials not supplied by Graco.

This warranty is conditioned upon the prepaid return of the equipment claimed to be defective to an authorized Graco distributor for verification of the claimed defect. If the claimed defect is verified, Graco will repair or replace free of charge any defective parts. The equipment will be returned to the original purchaser transportation prepaid. If inspection of the equipment does not disclose any defect in material or workmanship, repairs will be made at a reasonable charge, which charges may include the costs of parts, labor, and transportation.

THIS WARRANTY IS EXCLUSIVE, AND IS IN LIEU OF ANY OTHER WARRANTIES, EXPRESS OR IMPLIED, INCLUDING BUT NOT LIMITED TO WARRANTY OF MERCHANTABILITY OR WARRANTY OF FITNESS FOR A PARTICULAR PURPOSE.

Graco's sole obligation and buyer's sole remedy for any breach of warranty shall be as set forth above. The buyer agrees that no other remedy (including, but not limited to, incidental or consequential damages for lost profits, lost sales, injury to person or property, or any other incidental or consequential loss) shall be available. Any action for breach of warranty must be brought within two (2) years of the date of sale.

GRACO MAKES NO WARRANTY, AND DISCLAIMS ALL IMPLIED WARRANTIES OF MERCHANTABILITY AND FITNESS FOR A PARTICULAR PURPOSE, IN CONNECTION WITH ACCESSORIES, EQUIPMENT, MATERIALS OR COMPONENTS SOLD BUT NOT MANUFACTURED BY GRACO. These items sold, but not manufactured by Graco (such as electric motors, switches, hose, etc.), are subject to the warranty, if any, of their manufacturer. Graco will provide purchaser with reasonable assistance in making any claim for breach of these warranties.

In no event will Graco be liable for indirect, incidental, special or consequential damages resulting from Graco supplying equipment hereunder, or the furnishing, performance, or use of any products or other goods sold hereto, whether due to a breach of contract, breach of warranty, the negligence of Graco, or otherwise.

FOR GRACO CANADA CUSTOMERS

The Parties acknowledge that they have required that the present document, as well as all documents, notices and legal proceedings entered into, given or instituted pursuant hereto or relating directly or indirectly hereto, be drawn up in English.

Les parties reconnaissent avoir convenu que la rédaction du présente document sera en Anglais, ainsi que tous documents, avis et procédures judiciaires exécutés, donnés ou intentés, à la suite de ou en rapport, directement ou indirectement, avec les procédures concernées.

TO PLACE AN ORDER or to identify the nearest Graco/MAGNUM distributor, contact us at 1-888-541-9788

*All written and visual data contained in this document reflects the latest product information available at the time of publication.
Graco reserves the right to make changes at any time without notice.*

For patent information, see www.graco.com/patents.

Original instructions. This manual contains English. MM 332655

Graco Headquarters: Minneapolis
International Offices: Belgium, China, Japan, Korea

GRACO INC. AND SUBSIDIARIES • P.O. BOX 1441 • MINNEAPOLIS MN 55440-1441 • USA

Copyright 2013 Graco Inc. All Graco manufacturing locations are registered to ISO 9001.

www.graco.com
Revised July 2014